

Track and Trace – explained a little different

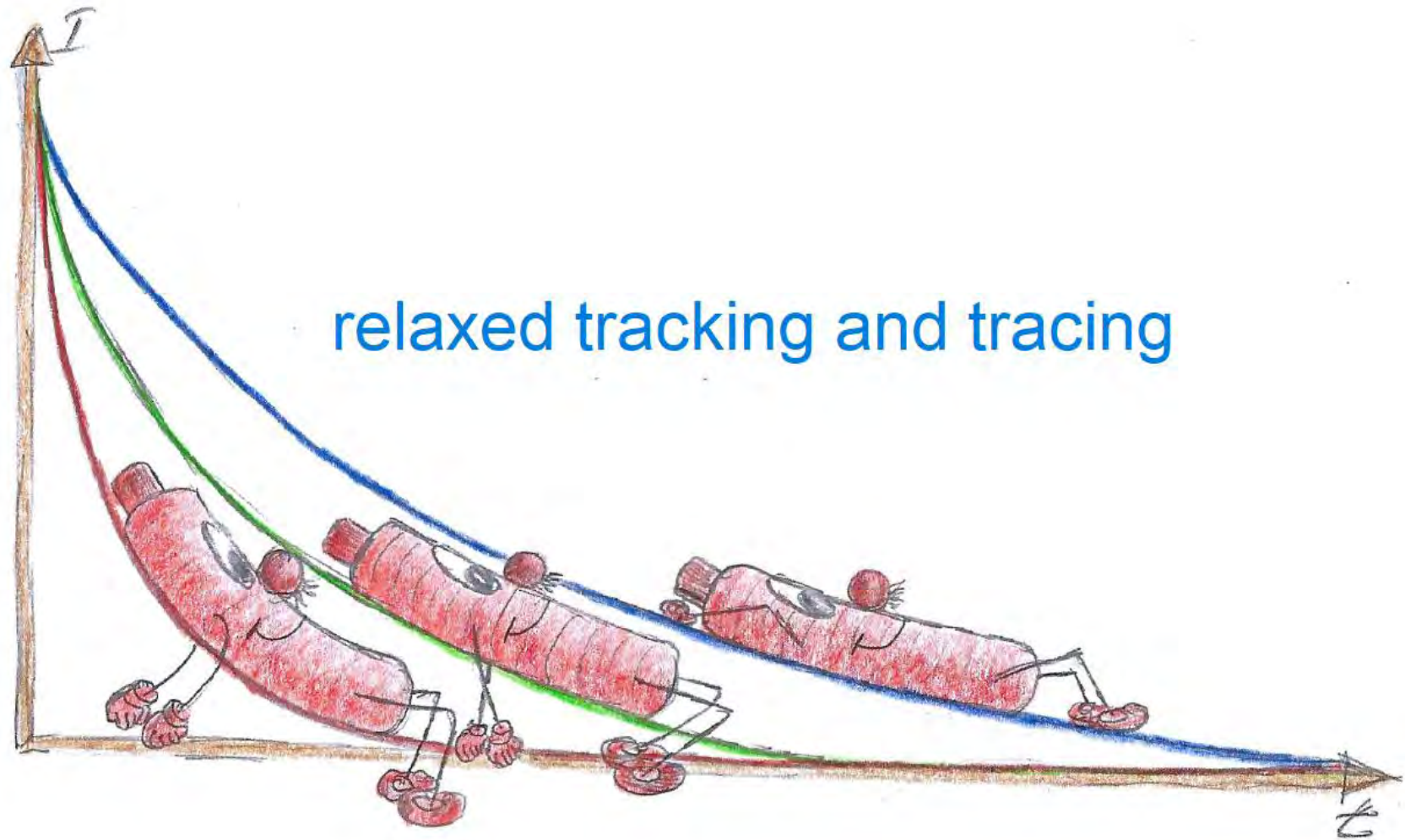

CLEAN and TOMATO

TRACK and TRACE
Marker Based Sorting

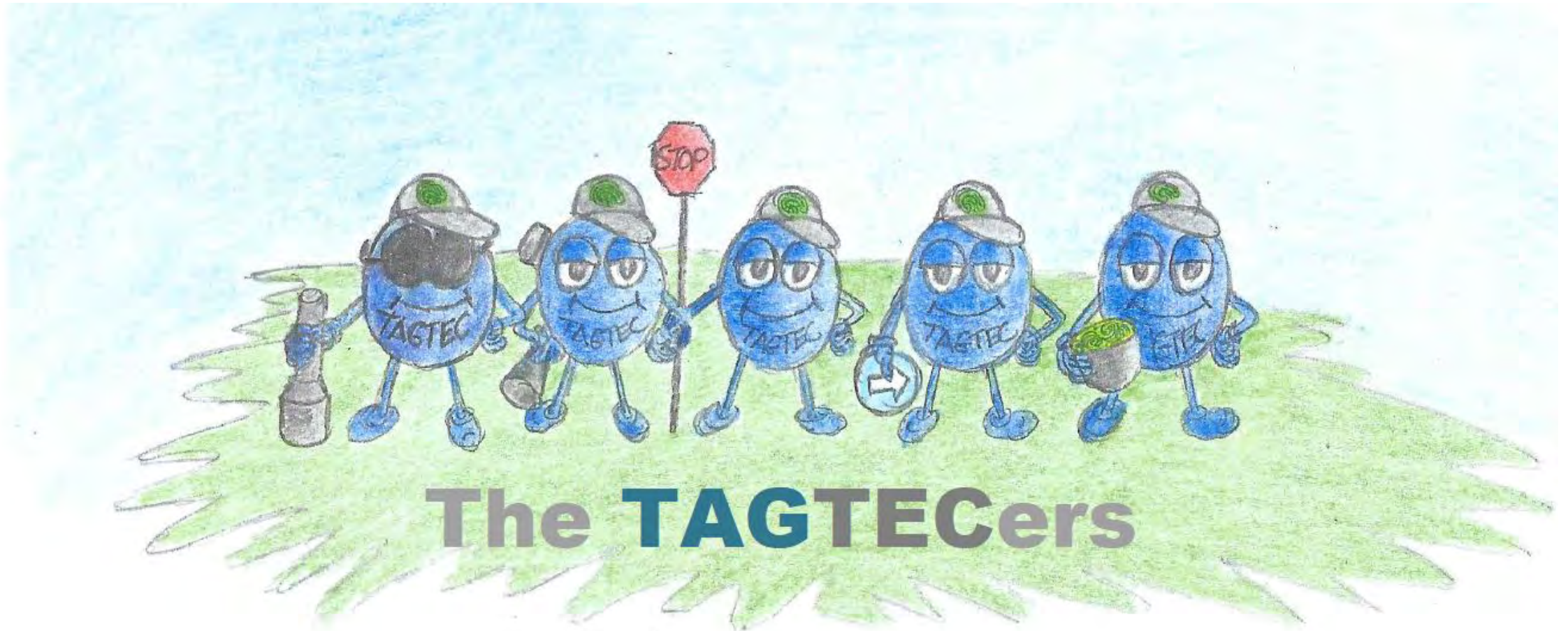

I am the eye of the TAGTEC - technology. With my lamp and my filter glasses I can easily detect and distinguish the TAGTEC - markers.

I am responsible for the transmission of information. After recognizing the marker, I pass the message on to the sorters.

We are the sorters. We are told what is coming and then we direct what is coming in the intended direction.

I am responsible for marking the products. With the available TAGTEC - markers, it's up to me what the individual ingredients ultimately become. Once FOOD, always FOOD. Once NONFOOD always NONFOOD!



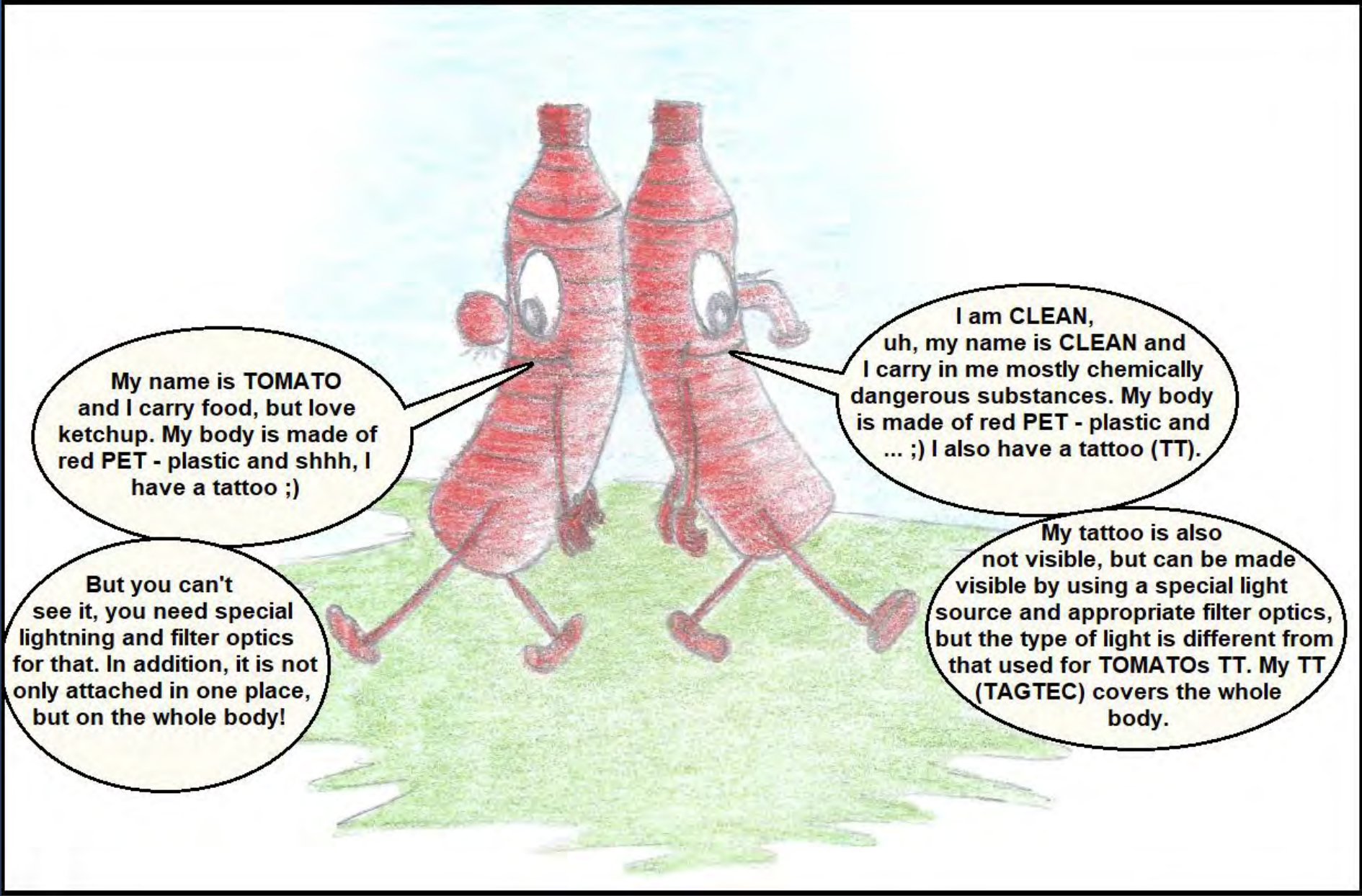

My name is **TOMATO** and I carry food, but love ketchup. My body is made of red **PET** - plastic and shhh, I have a tattoo ;)

But you can't see it, you need special lightning and filter optics for that. In addition, it is not only attached in one place, but on the whole body!

I am **CLEAN**, uh, my name is **CLEAN** and I carry in me mostly chemically dangerous substances. My body is made of red **PET** - plastic and ... ;) I also have a tattoo (**TT**).

My tattoo is also not visible, but can be made visible by using a special light source and appropriate filter optics, but the type of light is different from that used for **TOMATO**s **TT**. My **TT** (**TAGTEC**) covers the whole body.



Got a new order:
Production of CLEANS.
For this purpose, I use the
TAGTEC masterbatch with
the C markers, which
can be excited with
red light.

Watch out!
Now comes CLEAN!
And my tattoo, uh, TAGTEC, or
in short, my TT, I already have. But
no one can see it, because it
requires a certain light and a
special filter optics.



So and now
the TOMATOS, I use
the TAGTEC
masterbatch with the F
markers. The markers
react only to
NIR light.

Get off the track!
Now comes TOMATO!
Also my TTs can be made visible
under a certain light, in my case
NIR - light and with the help of a special
filter optics. In no way do my TTs react
to red or even blue light.
Cool, right?



Always nicely
after the nose and then I
will find my load already, but
always be careful, after all, I have a
responsible job to do. In any case
one thing is certain, and that is
that I will stay on this path!



So now I just
have to find the right way
to pick up my food load. I hope,
that I will be allowed to transport
the tomatoes in liquid form. I love
tomatoes. Ah, here comes the first
control station. I'll ask the
TAGTECers there right away
Let's go!

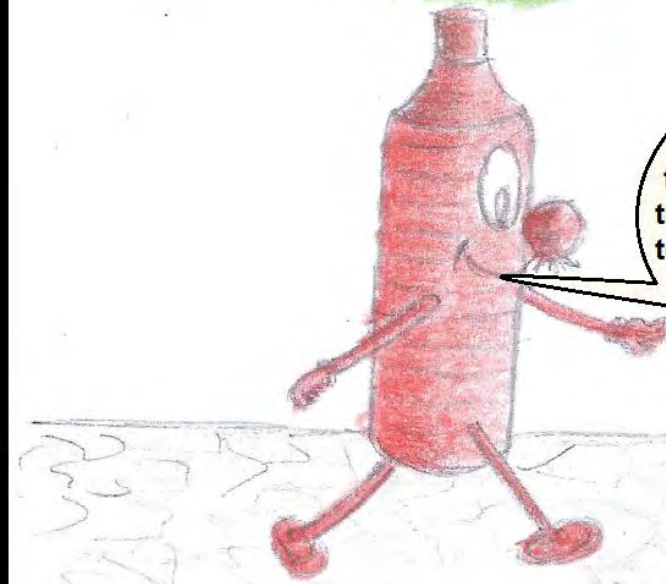

Ok, thanks to my TTs I get past the control. So the journey continues!

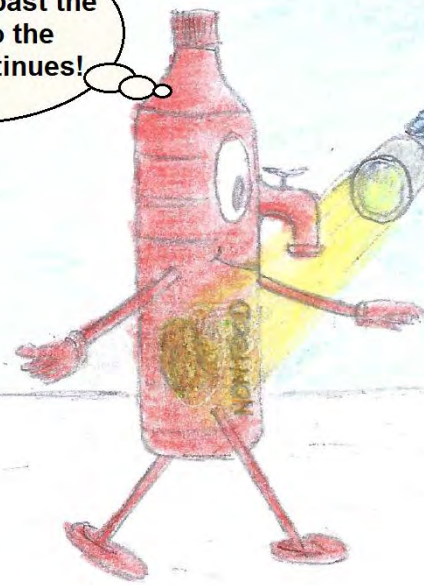

Checked!
Hi CLEAN!
You can pass!



I see! That's what my tattoo, uh TAGTEC, is good for! Otherwise there might have been problems here!



Ckected!
Hi TOMATO!
You can pass!
FOOD!





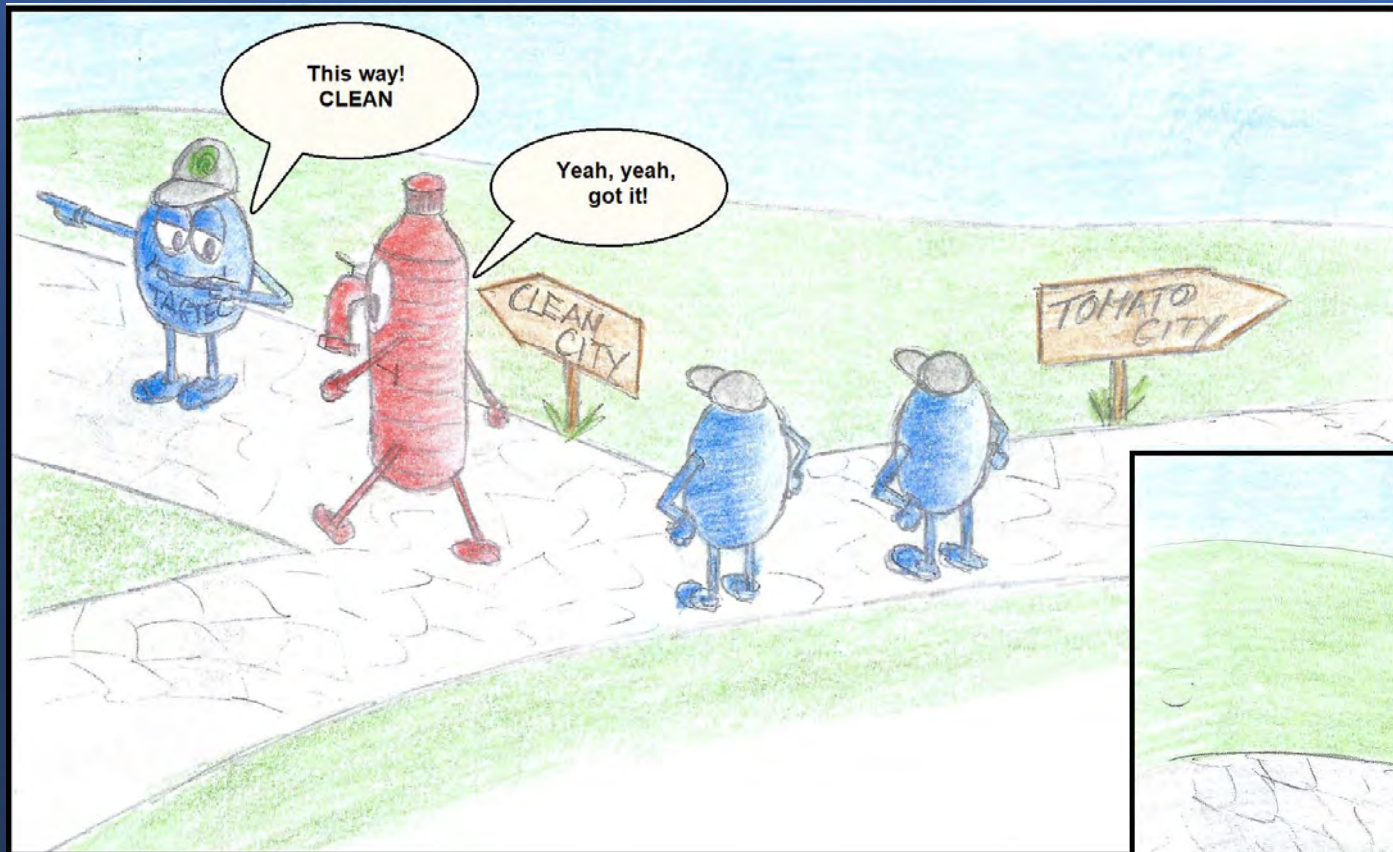

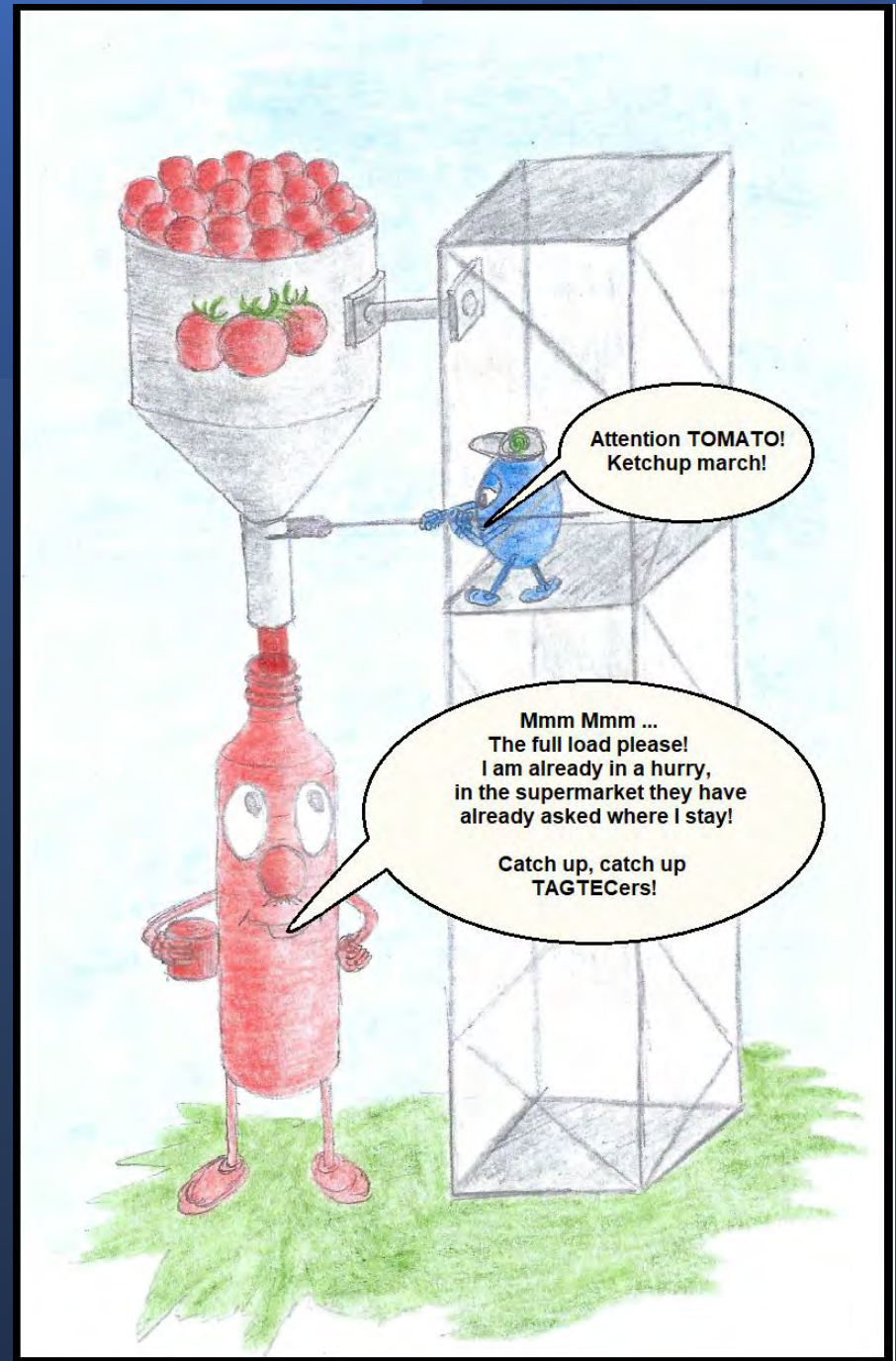
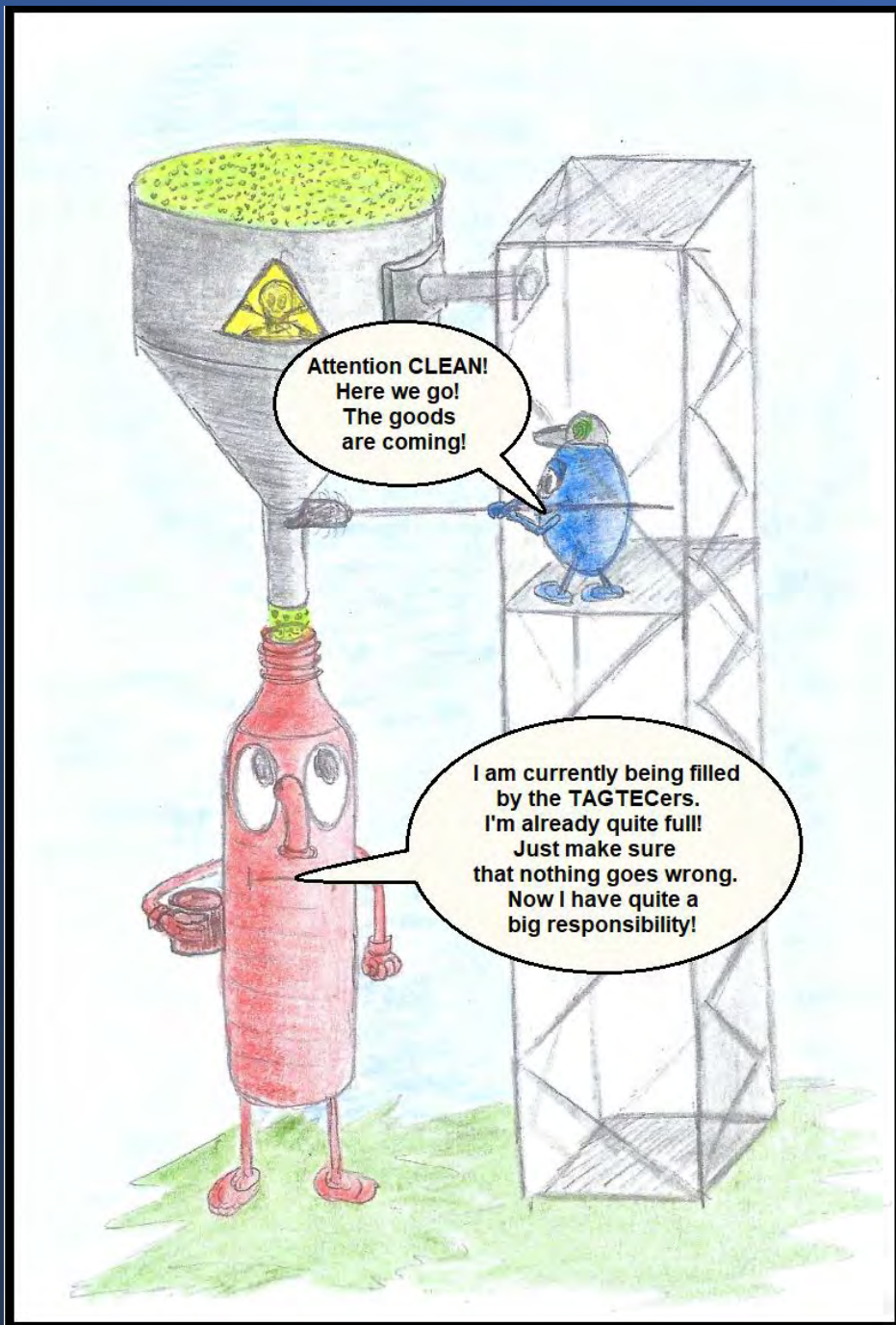

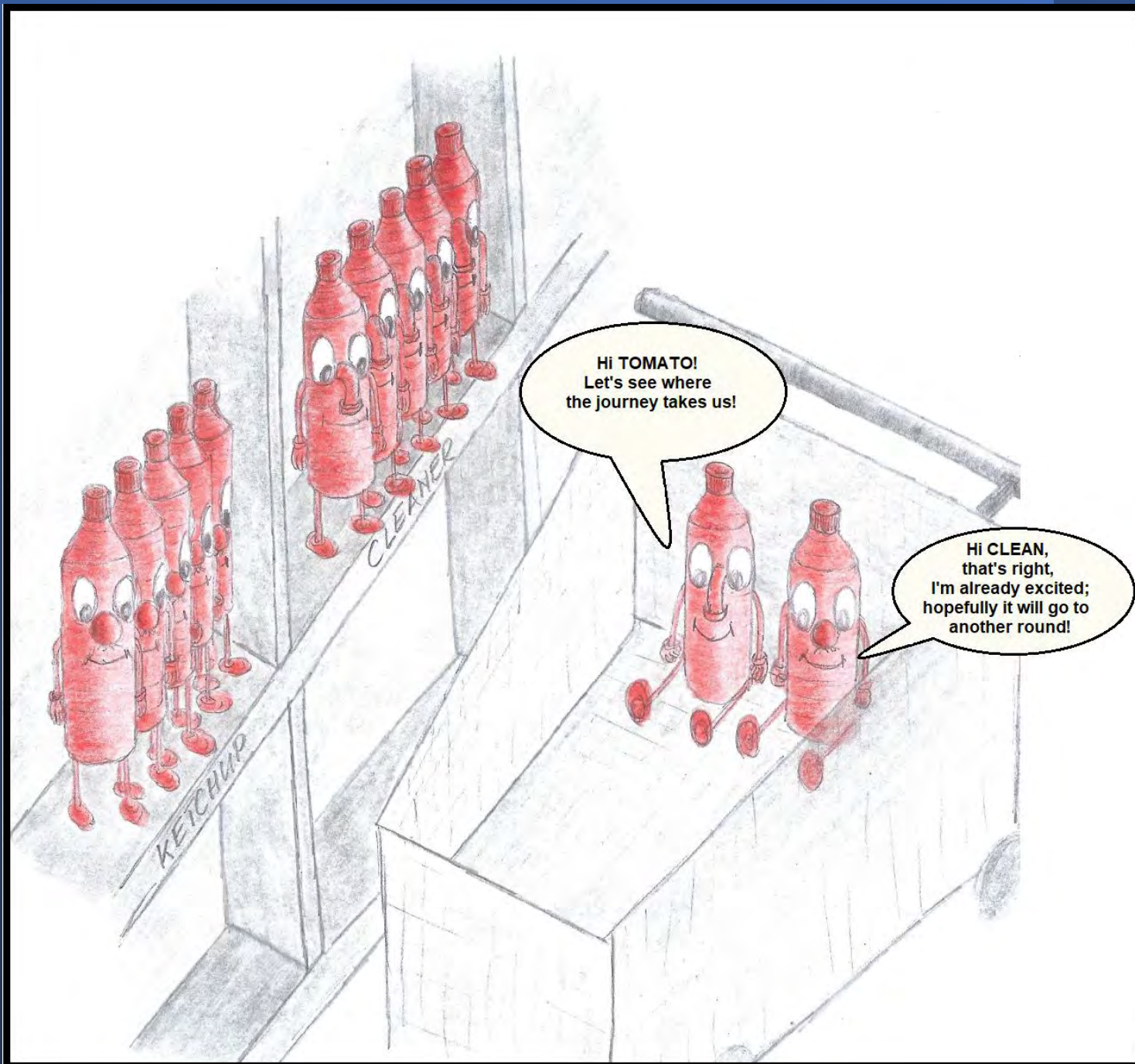



Hey TOMATO!
Are you okay?
I feel sooo empty!

Hi CLEAN!
I feel the same!
"Weak as bottle
empty" :(



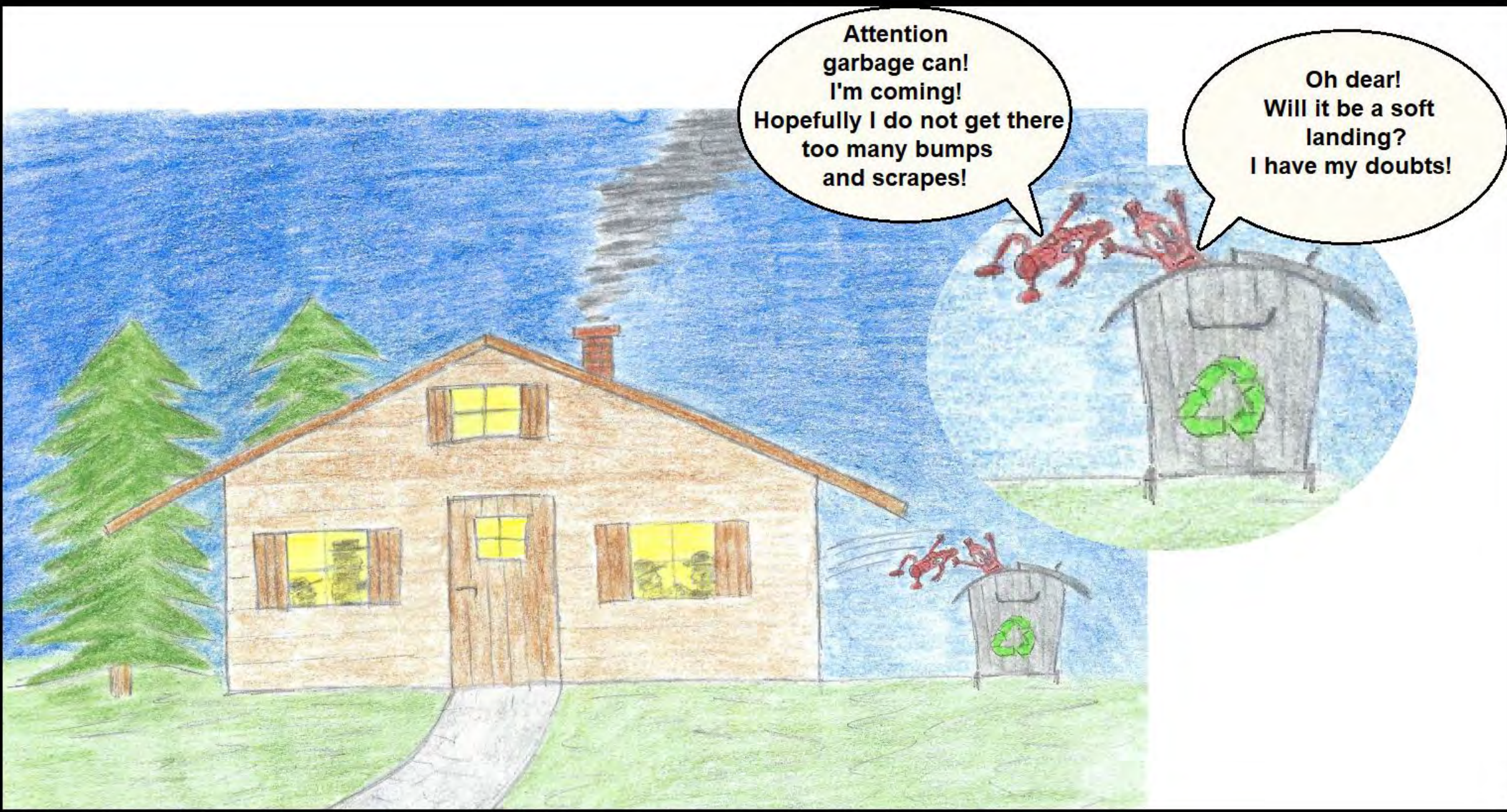

Attention
garbage can!
I'm coming!
Hopefully I do not get there
too many bumps
and scrapes!

Oh dear!
Will it be a soft
landing?
I have my doubts!



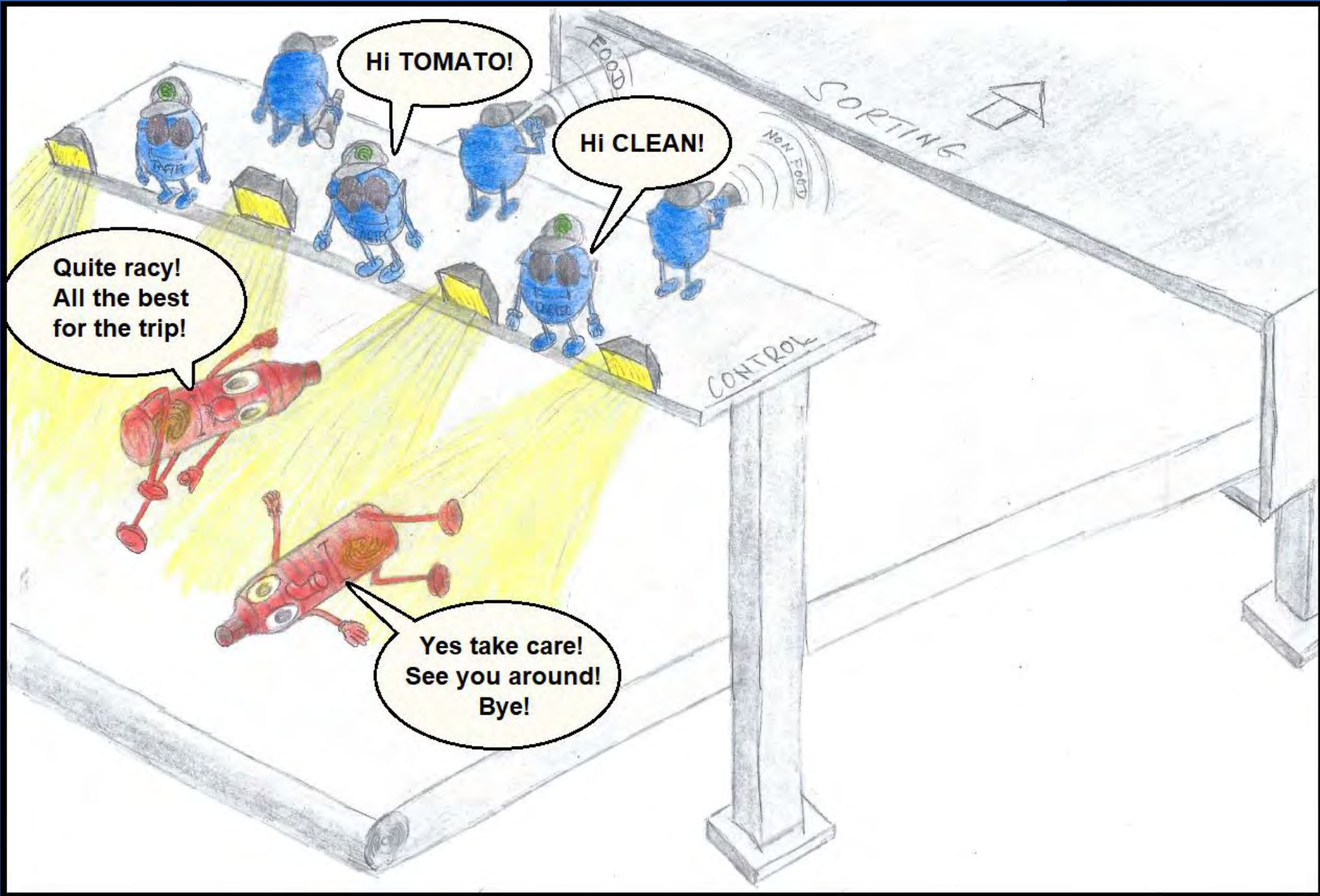

HI TOMATO!

HI CLEAN!

Quite racy!
All the best
for the trip!

Yes take care!
See you around!
Bye!

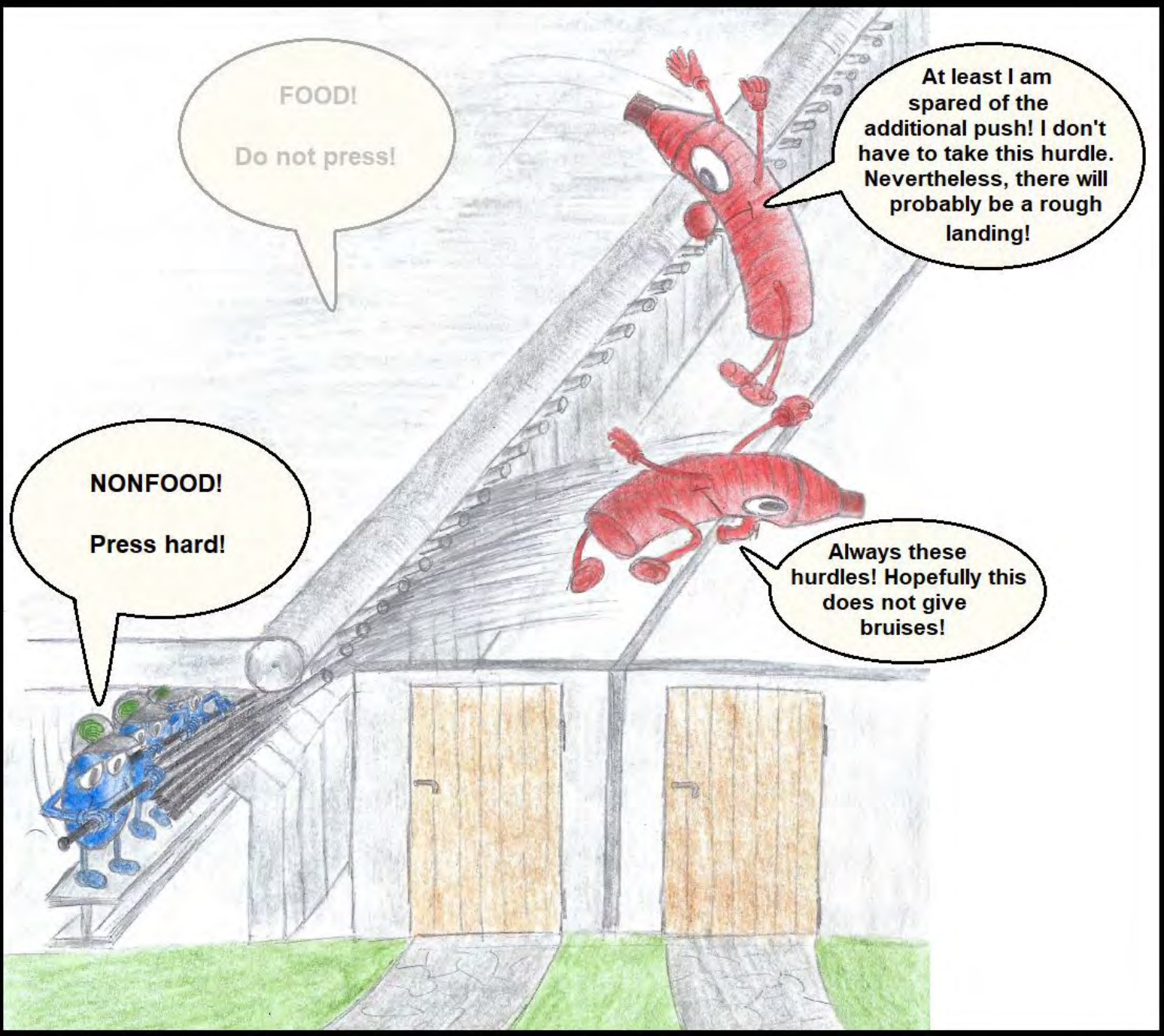

FOOD!
Do not press!

At least I am spared of the additional push! I don't have to take this hurdle. Nevertheless, there will probably be a rough landing!

NONFOOD!
Press hard!

Always these hurdles! Hopefully this does not give bruises!

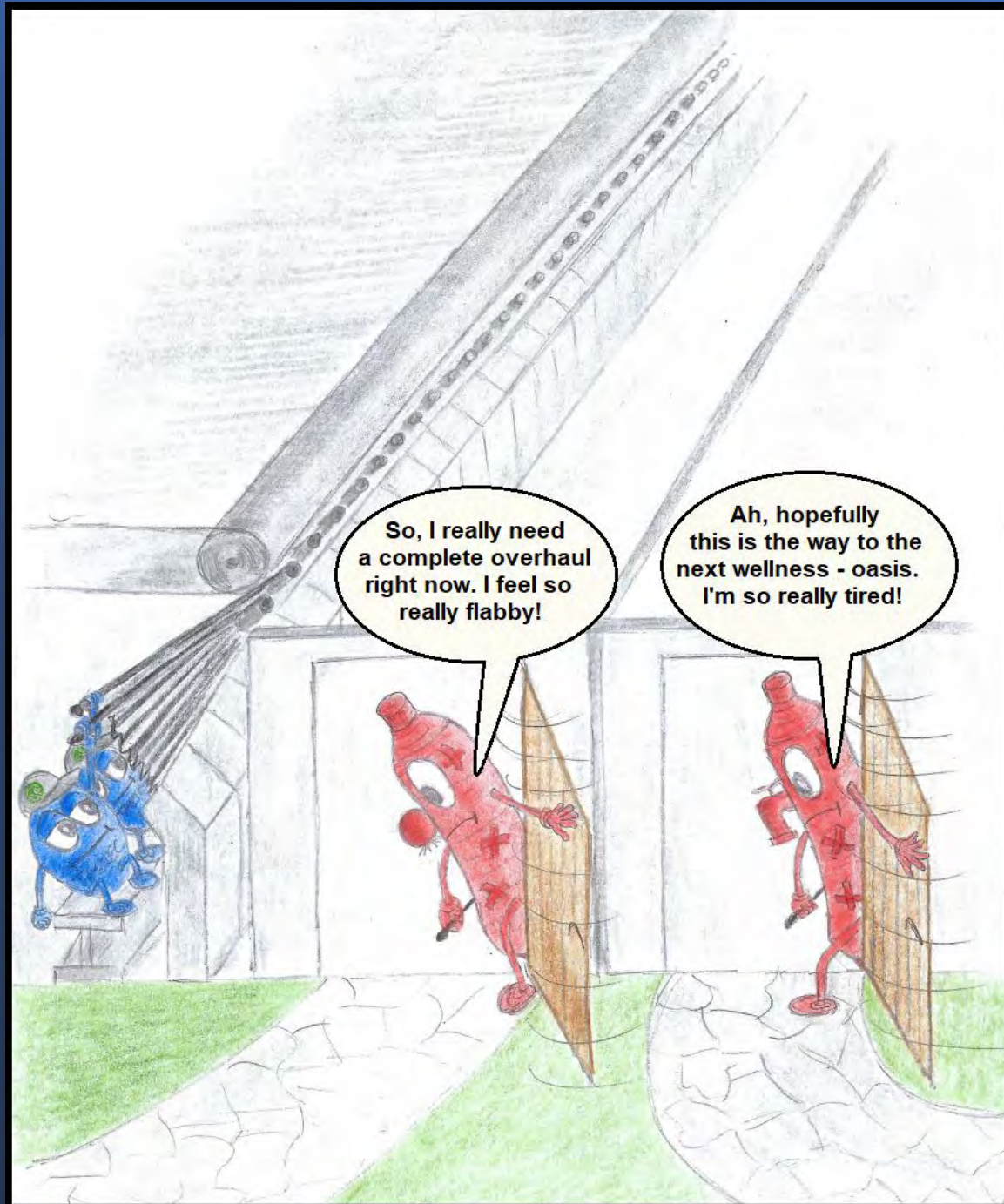



Now I'm a bit
scared of the next steps:
shredding - extruding -
injection molding!
it will,
it simply must work!



Oh dear,
what's coming up next?
- Shredding
- Extrusion
- Injection molding
Well, I hope they
patch me up again!



blubb blubb blubb

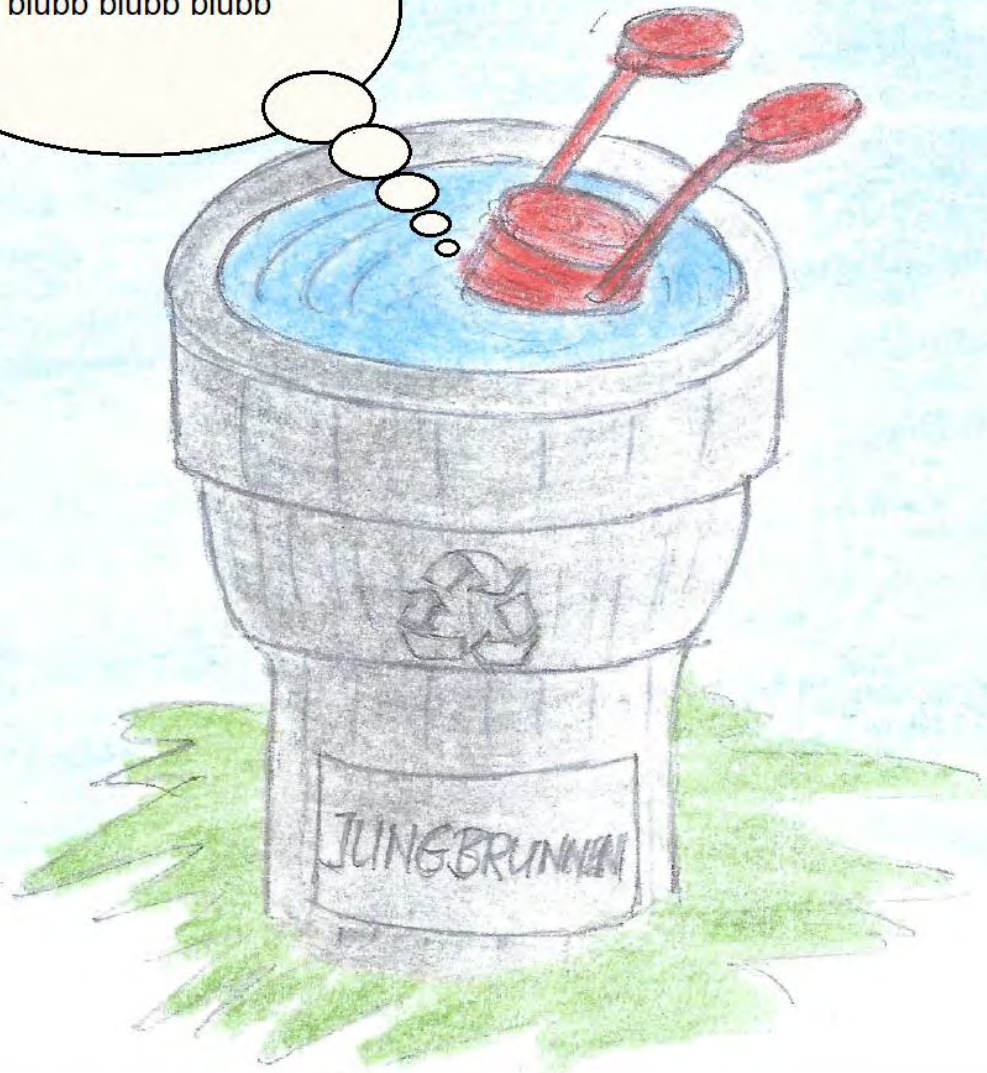

blubb blubb blubb





Beautiful is the
YOUTH!
It comes back!



I feel like
NEW BORN :)

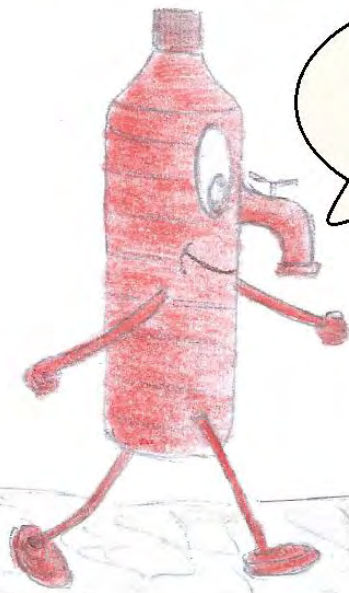

I find my way.
With certainty!



I play
it safe and stay
on the path.

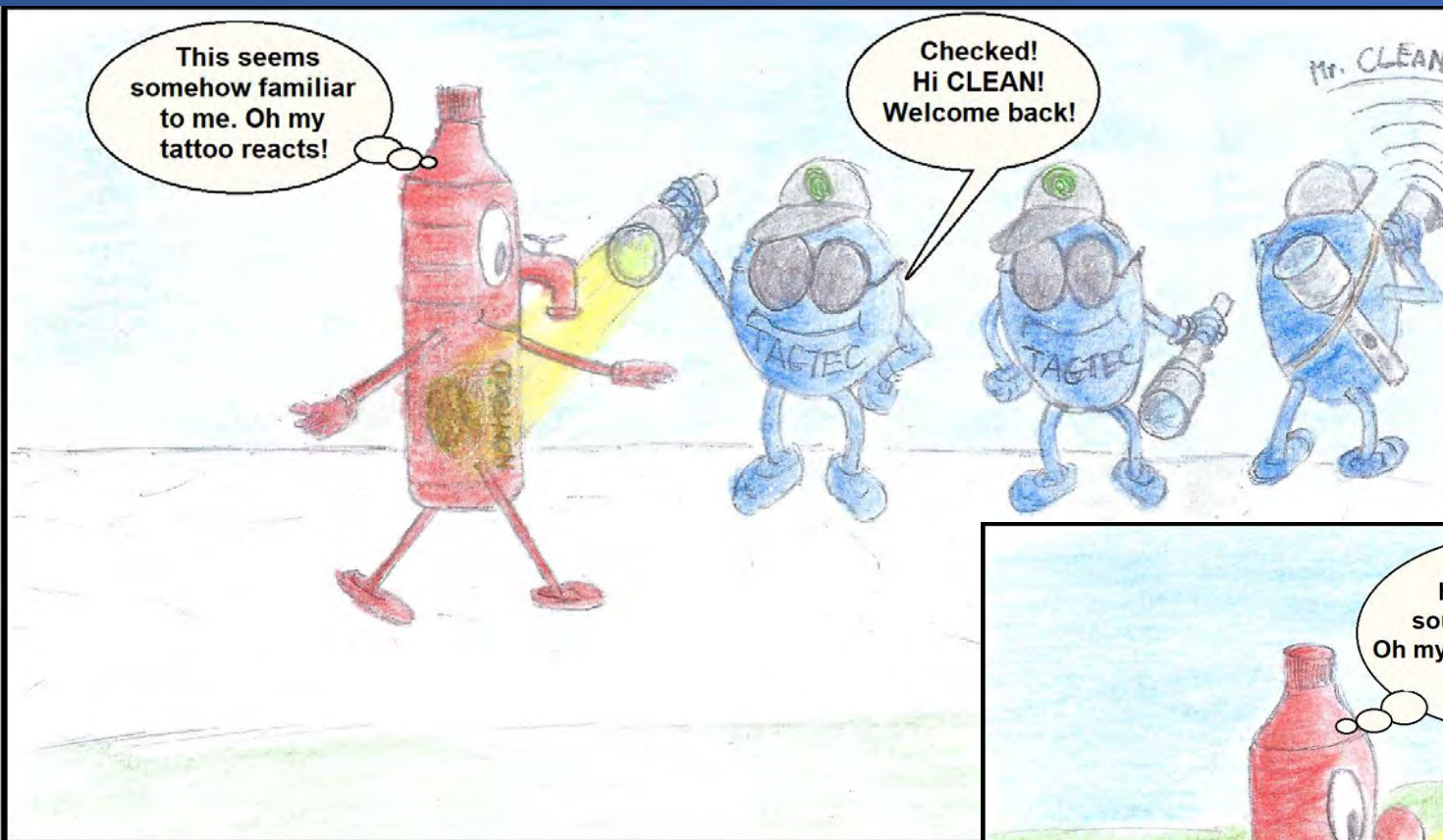



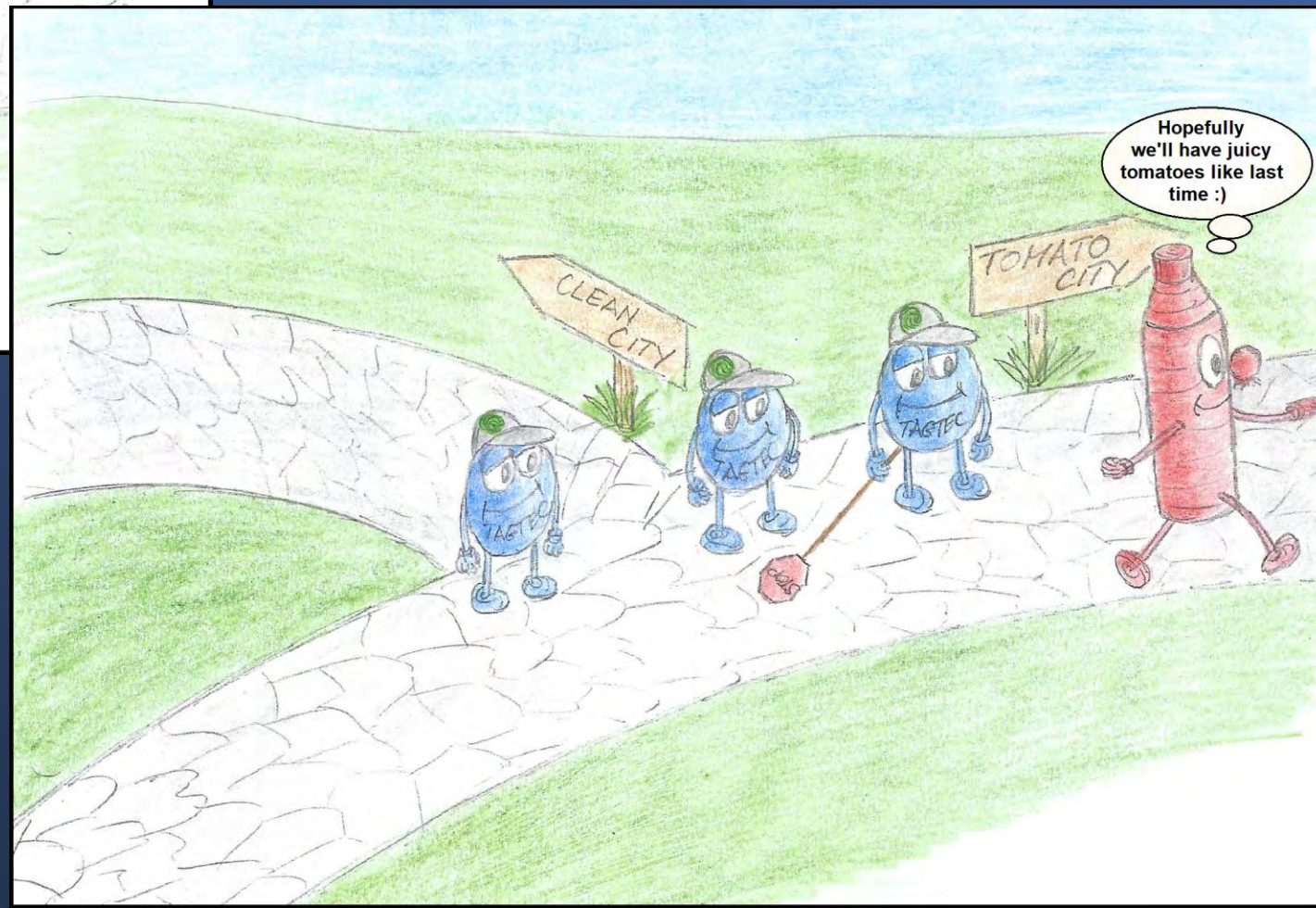
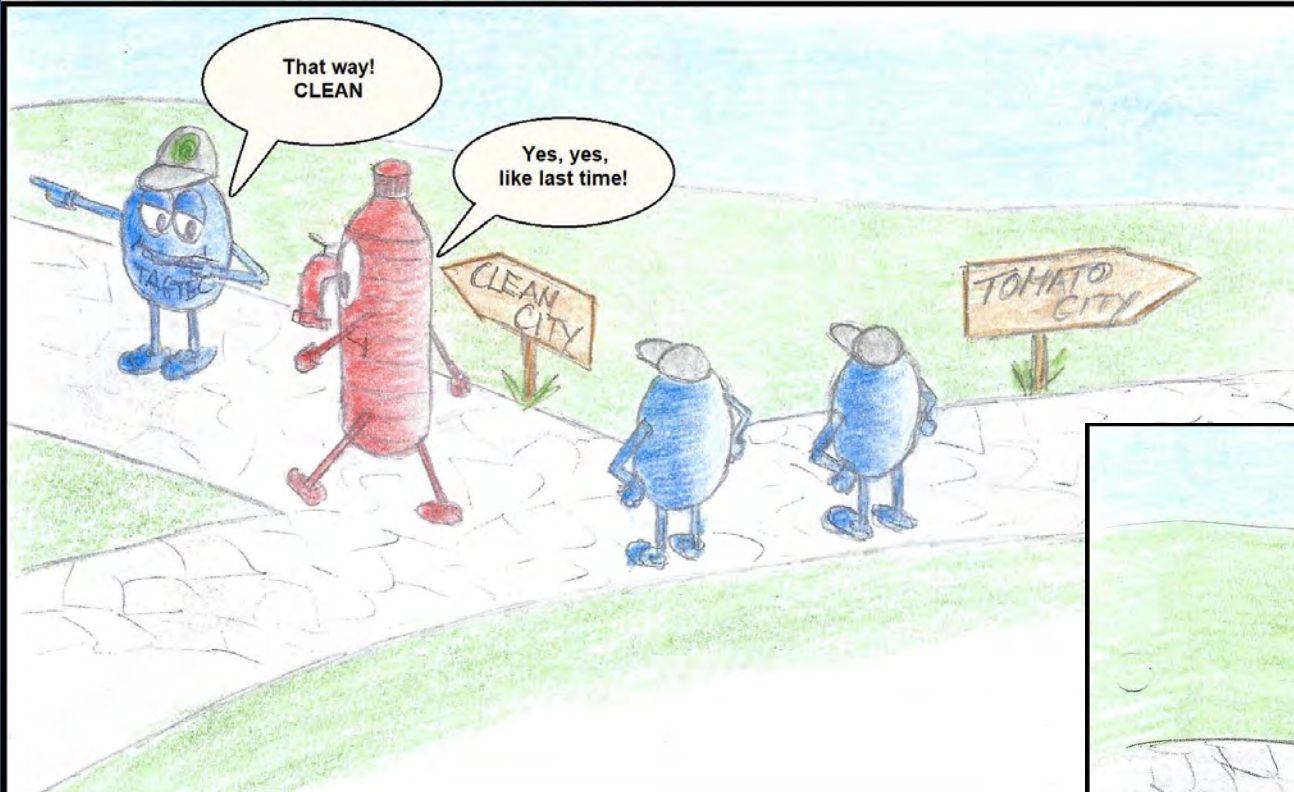

A brief comparison with reality

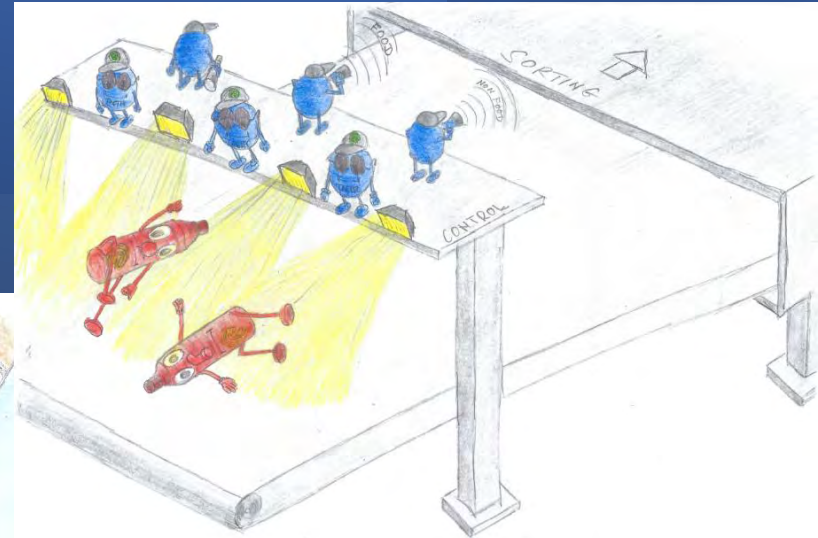
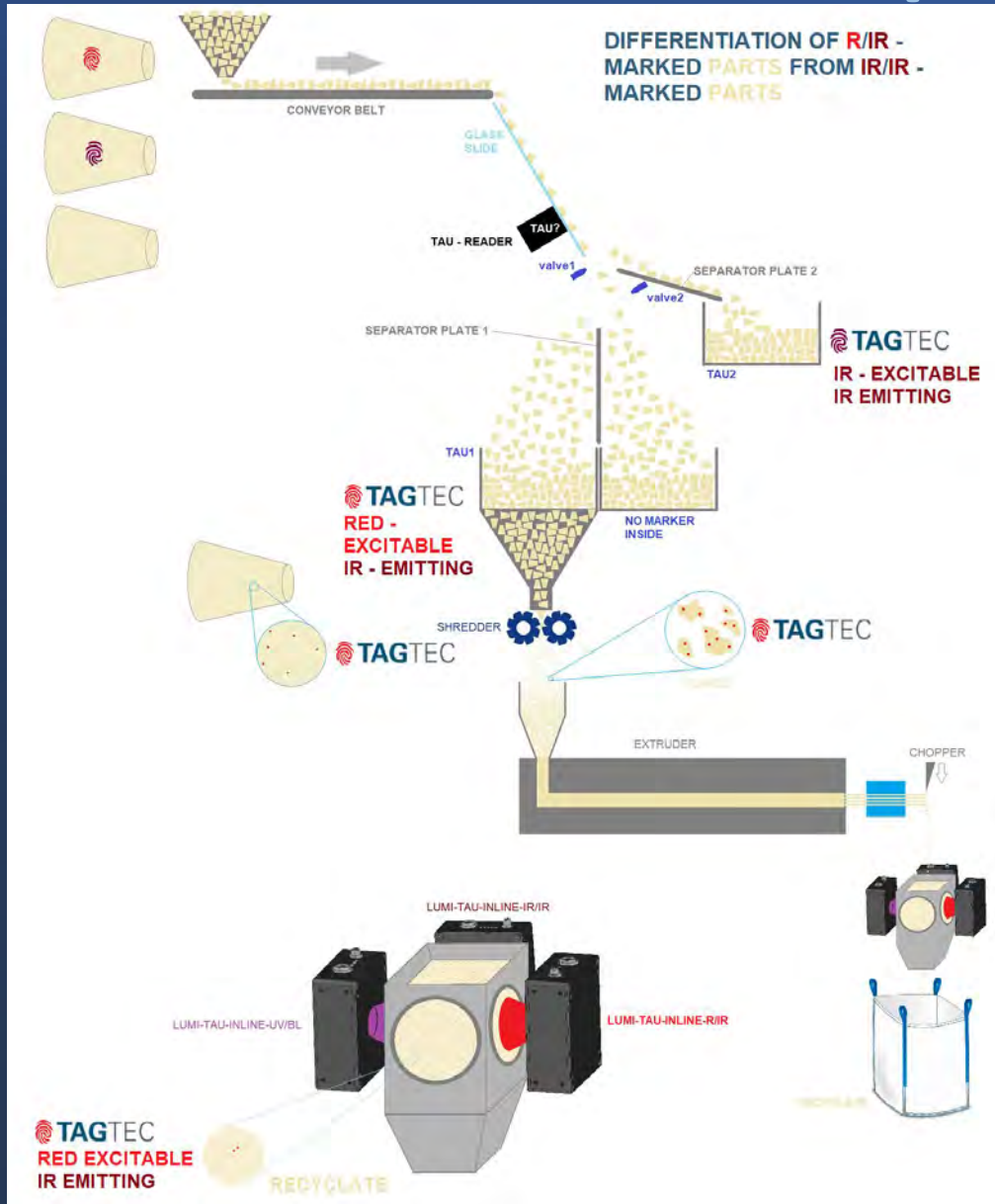

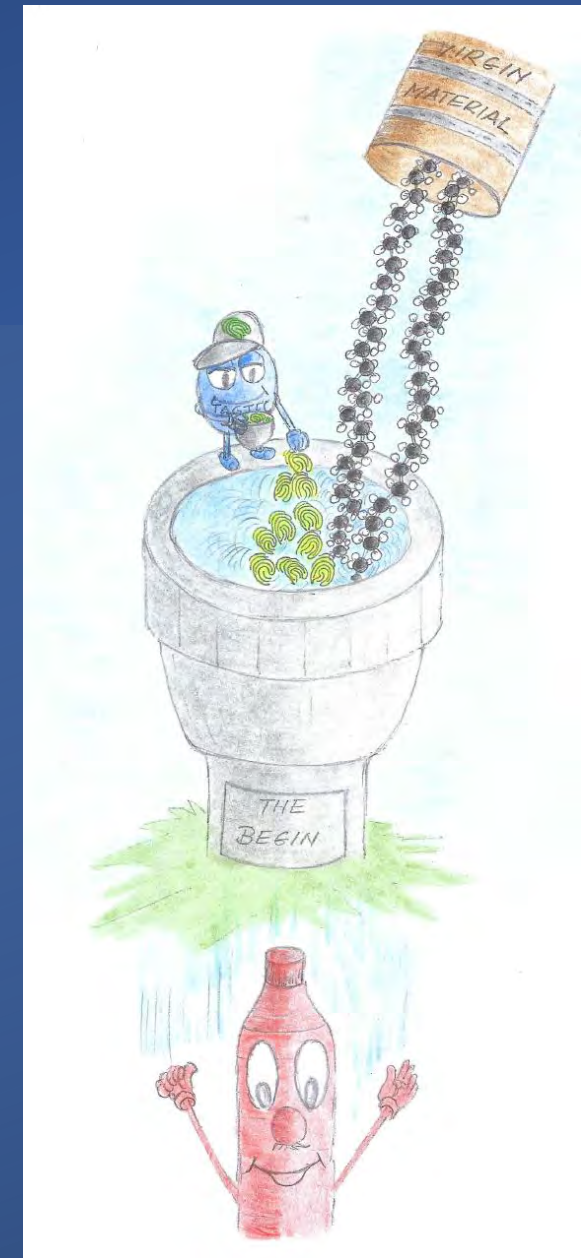
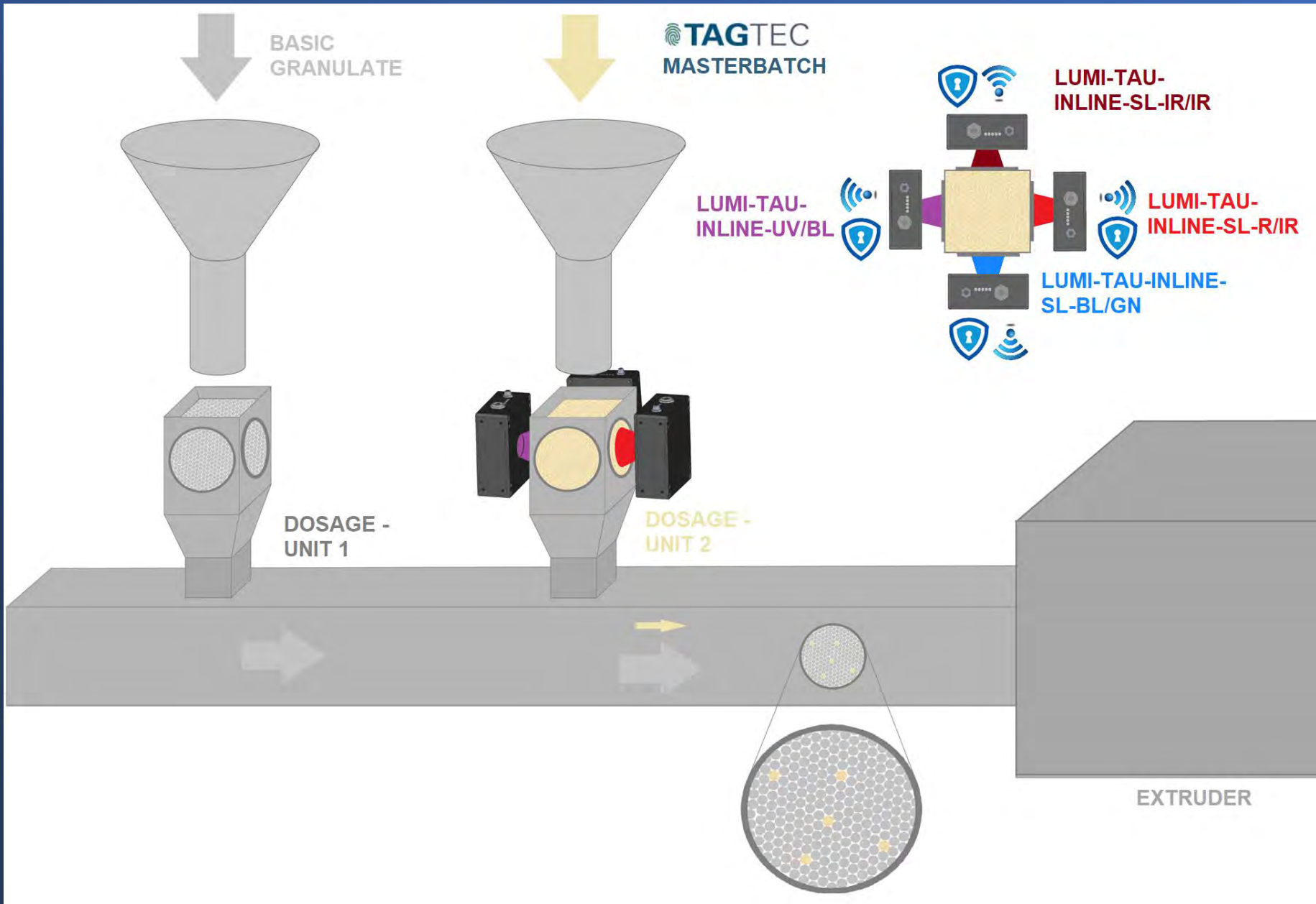

In the following, a concept will be presented that enables a clear allocation of the plastic packaging in its respective physical state. By means of suitable marker technology, a marked package or parts of the package, for example flakes or pellets, can be assigned to a specific group. By using different markers, different groups can be defined, for

example:

- Food
- Detergents
- Body care
- Chemical special products

At best, the plastic material should be reassigned to the same use, the same group, after a complete cycle.



FROM PELLETT TO PELLETT

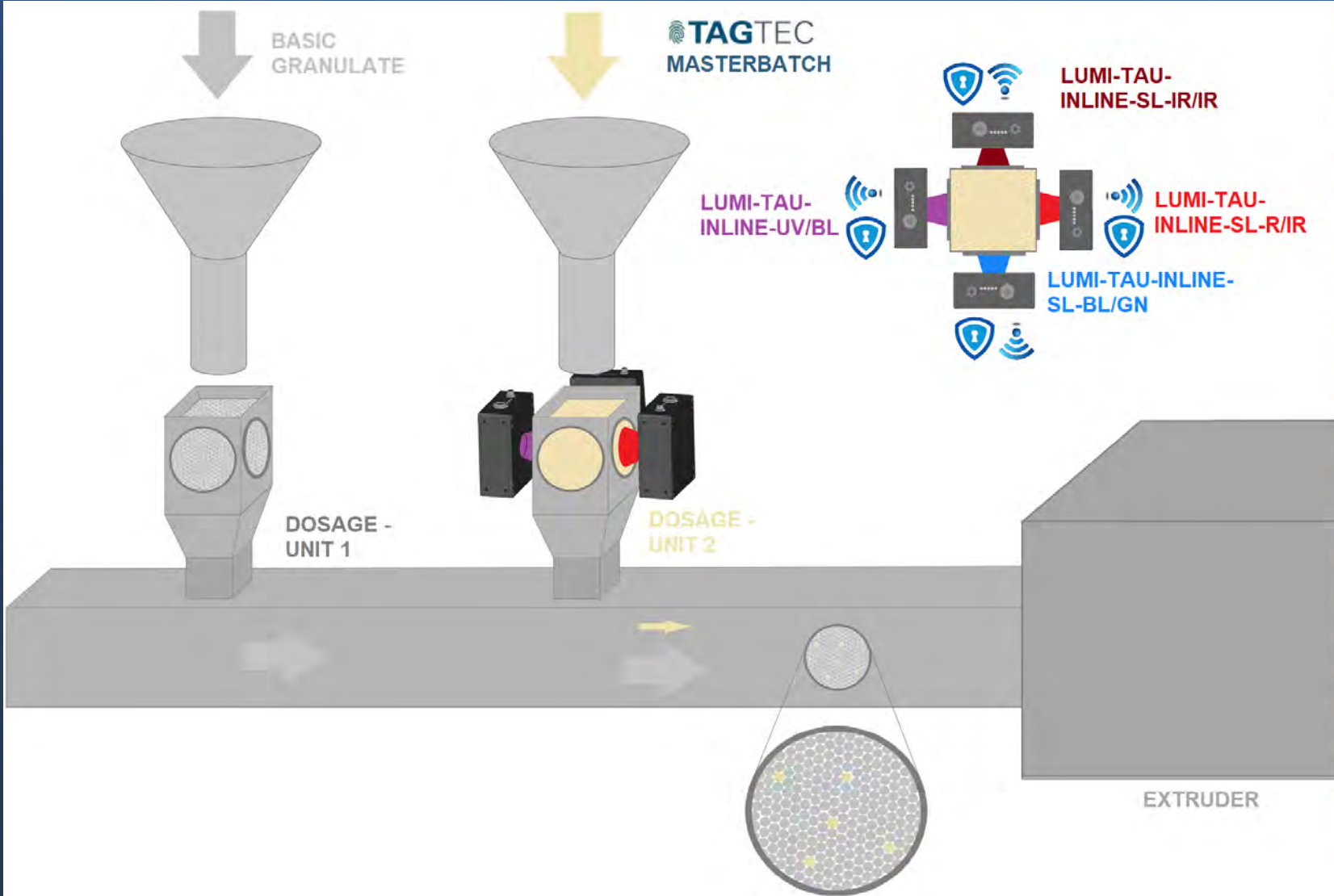

For example, the first life cycle of a plastic package starts with an appropriately marked (with TAGTEC - marker), which is selected depending on the respective group membership: FOOD, DETERGENTS, BODY CARE and CHEMICAL SPECIAL PRODUCTS. The dosing units can be used to determine the marker concentration in the plastic packaging. Sensors are used to check whether the correct marker is used in the correct concentration. The TAGTEC - markers are designed in such a way that they do not interfere with each other. In the extruder, the granulate mixture is liquefied and with the help of a suitable injection mold, the production of the desired plastic packaging can take place. The TAGTEC - marker is correspondingly robust and therefore resistant to temperature and pressure. The TAGTEC - marker particle size is only a few μm .

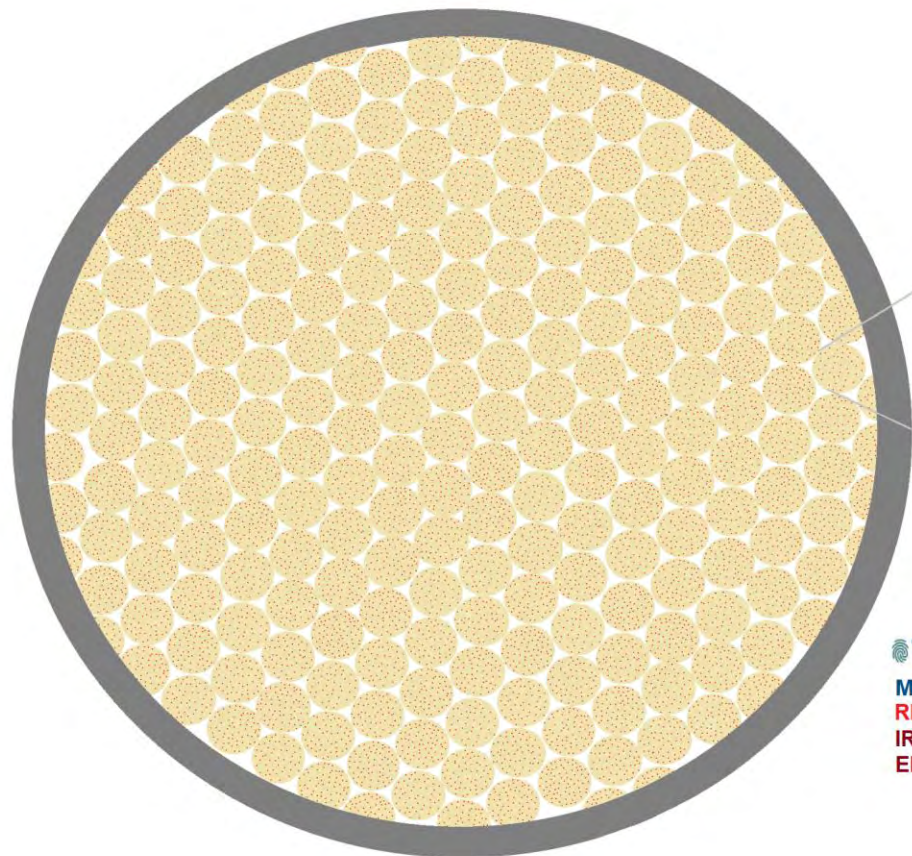

 **TAGTEC**
MASTERBATCH
RED EXCITATION
IR SECONDARY
EMISSION

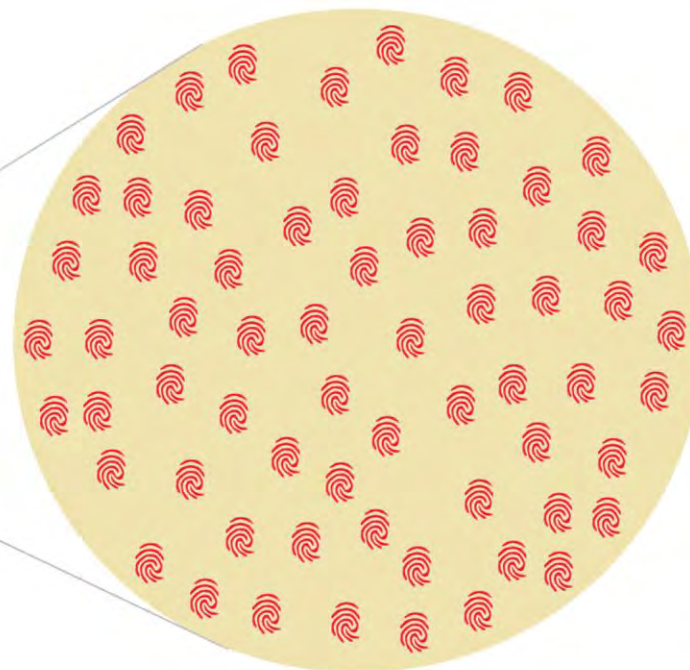

 **TAGTEC**

The TAGTEC - marker shown here can be excited using red light, with secondary emission in the near infrared (NIR) range. The marker shows phosphorescent behavior. The duration of the afterglow serves as a measured variable (TAU). In addition to the TAGTEC - marker that can be excited in the red and respond in the NIR range, there are markers that can be excited in the UVA range and provide a time-delayed optical response in the visible wavelength range. Furthermore, there are markers that can be excited with blue light (the time-delayed optical response is then in the green wavelength range, for example) and then there are NIR excitable markers, whose time-delayed response is also in the NIR range. The smallest amounts of marker are sufficient for the plastic packaging and parts of the plastic packaging (flakes, pellets) to be reliably detected by the respective sensor system.

LUMI-STAR - TECHNOLOGY:
INDIVIDUAL RECOGNITION AND TRACKING



LUMI-STAR-INLINE-R/IR

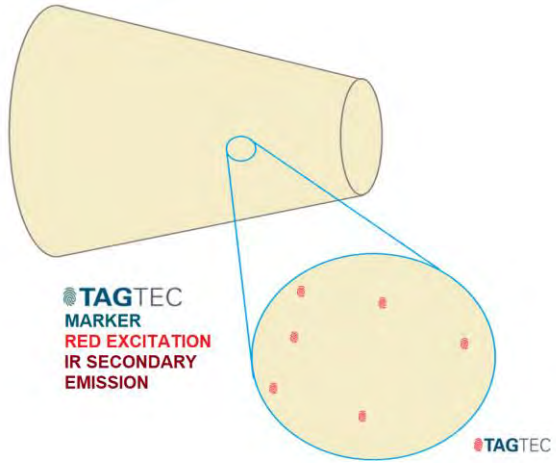

EXTRUDER

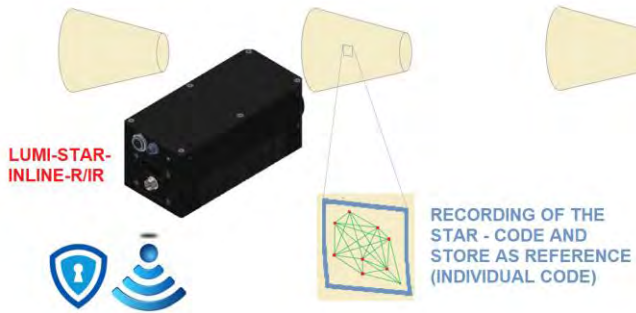
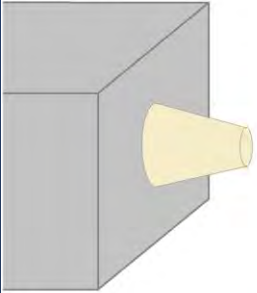

LUMI-TAU TECHNOLOGY:
MARKER - DETECTION

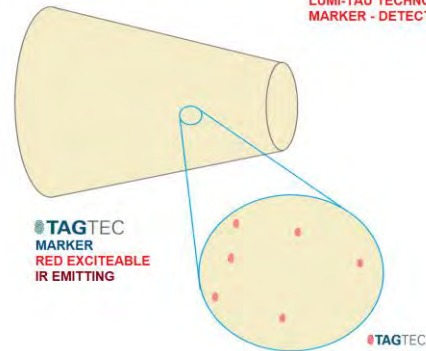

LUMI-TAU-MOBILE-CL-R/IR

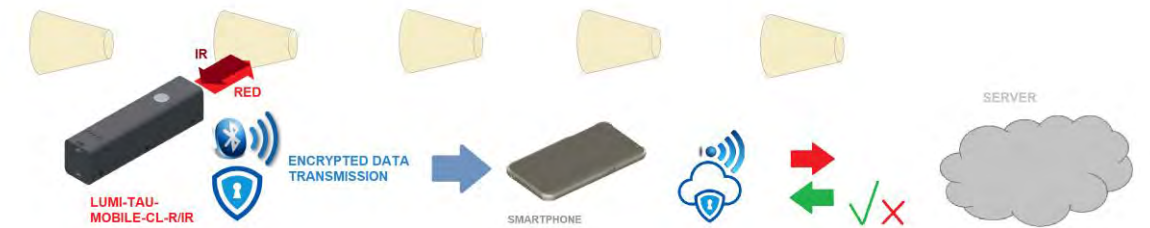

**LUMI-STAR - TECHNOLOGY:
INDIVIDUAL RECOGNITION AND
TRACKING**

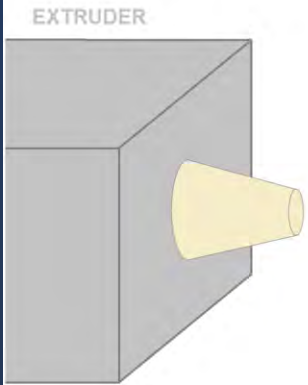
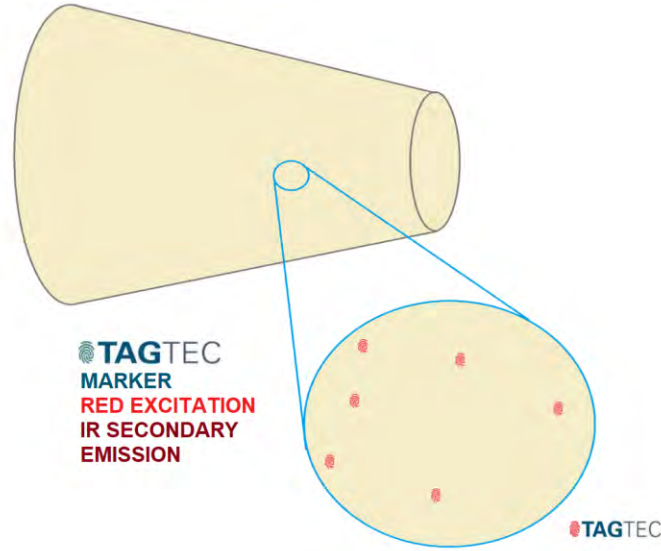

In addition to the identification of group membership defined by respective TAGTEC - marker, it is now also possible to generate an individual code (the so-called STAR code) for the plastic after the injection molding process using STAR technology. During illumination of a specific area (approx. 10mm x 10mm) on the packaging, with light of the appropriate excitation wavelength, the TAGTEC - marker particles are excited to fluoresce, forming an individual "star pattern". The constellation of the luminous particles is stored in the system in coded form for each plastic packaging recorded as a reference. In addition to the UUID (Universally Unique Identifier), other data such as date, time, geodata, machine data and production data are usually stored in the system. When queried later, the UUID of the plastic packaging can now be recognized by means of the LUMI-STAR system.

LUMI-STAR - TECHNOLOGY: INDIVIDUAL CAPTURE

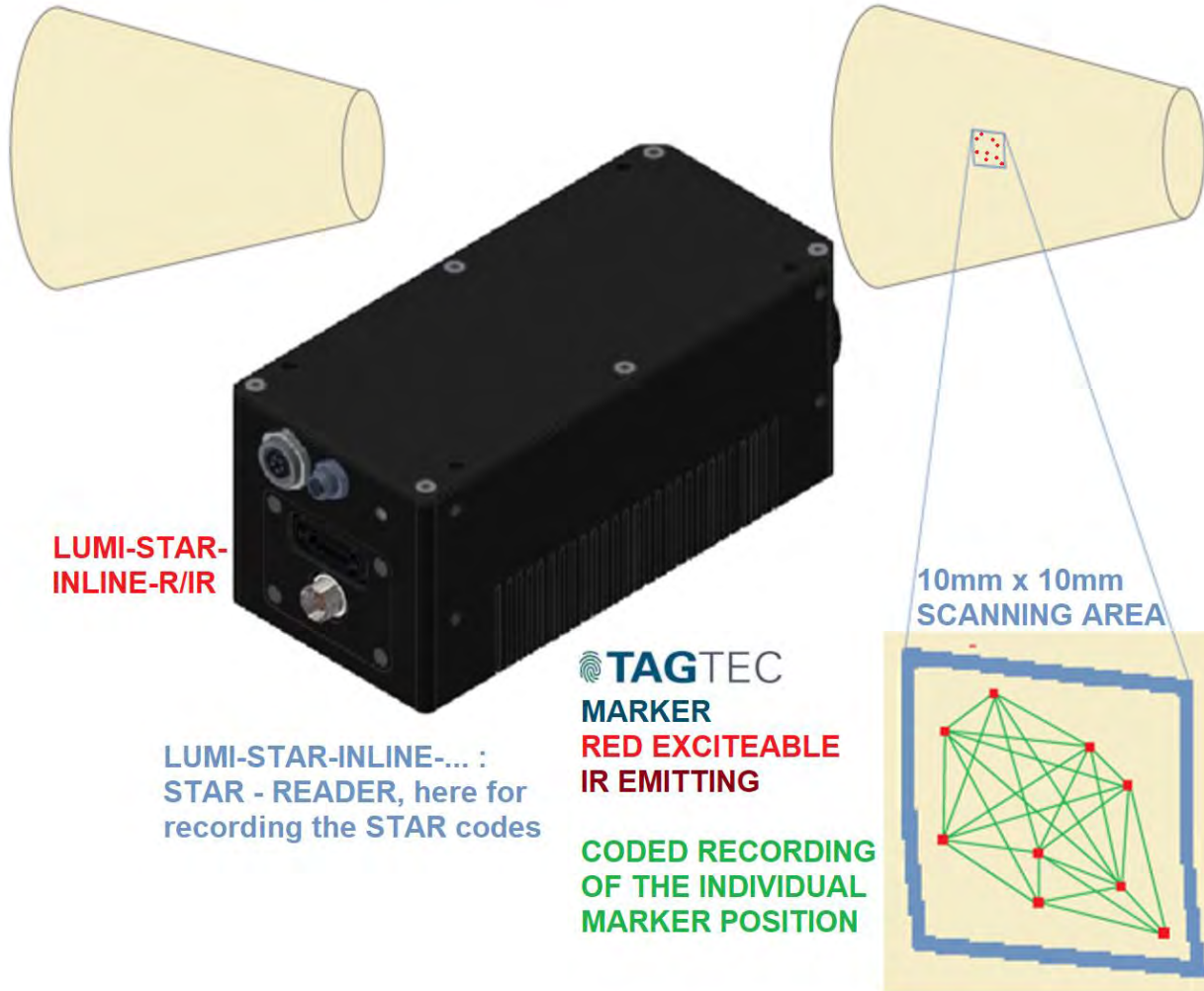

A few fluorescent particles in an area of 10mm x 10mm are sufficient to generate a unique individual code. The particle constellation (particle code) is transmitted encrypted via LAN to a server by means of LUMI-STAR-INLINE-... and stored there as a reference -> Particle Code Recording.

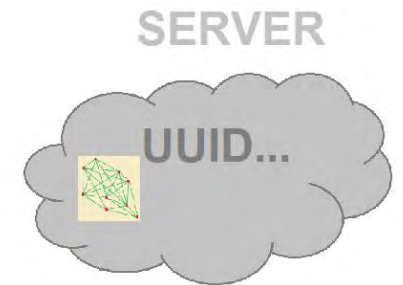

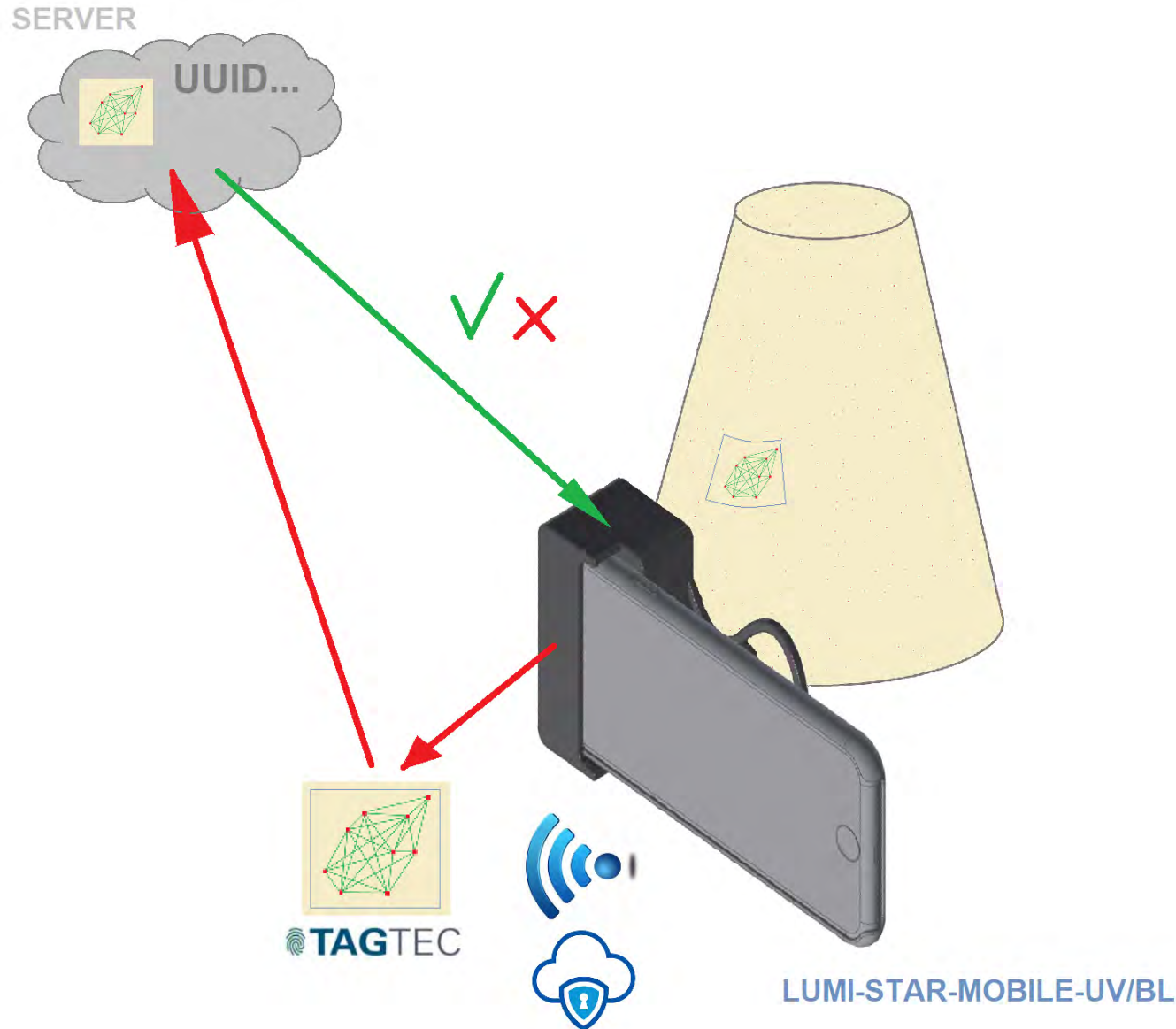

The STAR code can also be recorded on a mobile basis using the LUMI-STAR-MOBILE-... devices. The sensor system has been designed as a shell for this purpose, thus allowing it to hold a smartphone. Using the smartphone's image processing unit, the STAR code can now be recorded at the point on the packaging where the reference code was originally recorded using LUMI-STAR-INLINE-... immediately after production of the plastic packaging. The STAR code, including geodata, date and time, is then forwarded to the designated server in encrypted form via WLAN. This checks the STAR code and searches for the reference, the so-called digital twin. If there is a match, a corresponding entry is made in the supply chain software, otherwise an error message is displayed.

LUMI-TAU TECHNOLOGY:
MARKER - DETECTION

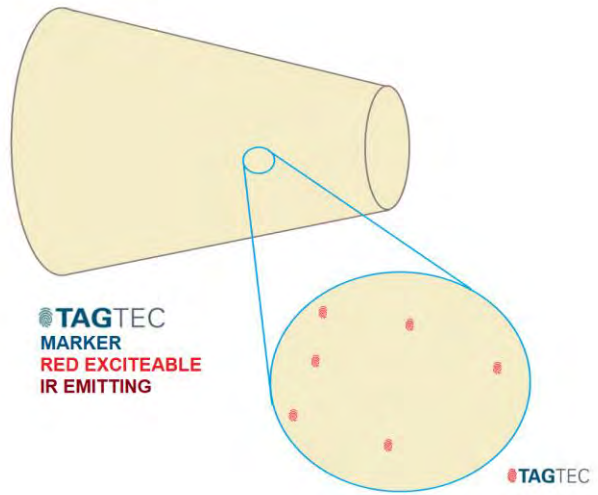

During the production of the plastic packaging, the TAU - Reader LUMI-TAU-INLINE-SL-... can be used to check inline whether the correct TAGTEC - marker is used in the appropriate concentration. Both the TAU value (the decay time constant of the response signal) and the intensity value INT of the signal can be monitored, and faulty objects can be sorted out in real time. Furthermore, the data can be passed on in encrypted form to supply chain monitoring software. Blockchain technology can then be used to track the product group throughout its lifecycle, if needed.

EXTRUDER

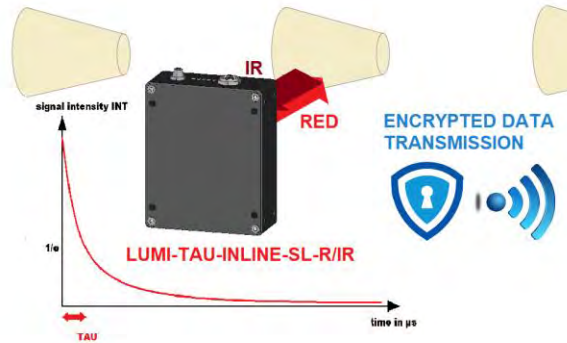
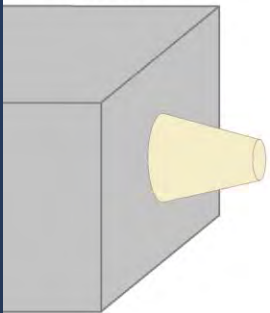

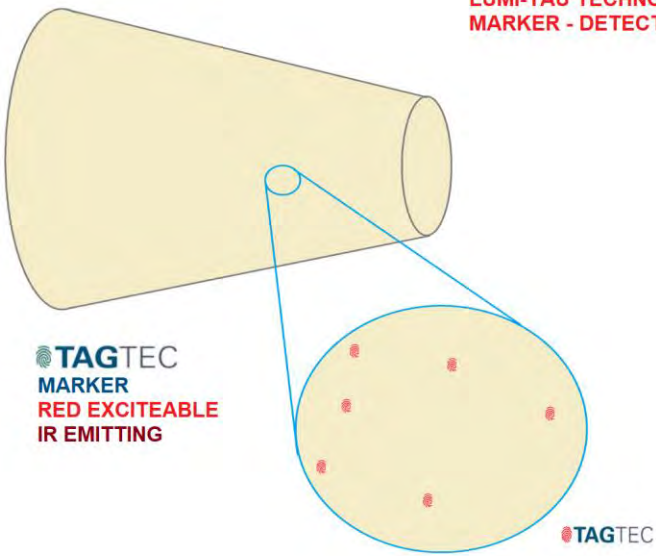

The physical size characteristic of the TAGTEC - marker can now also be recorded using the LUMI-TAU-MOBILE-... mobile unit. The mobile device can transmit measurement data such as time constant (TAU) and signal intensity (INT) together with the geodata, date and time in encrypted form via Bluetooth to a smartphone and via a smartphone to the server via WLAN, whose software monitors the supply chain, among other things. The APP of the smartphone then receives a feedback from the server that the supply chain has been correctly complied with or not complied with up to that point.

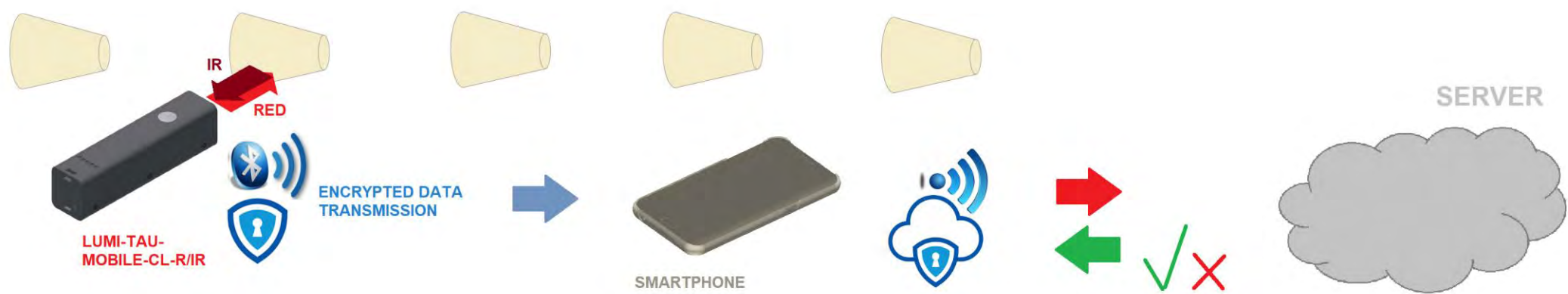

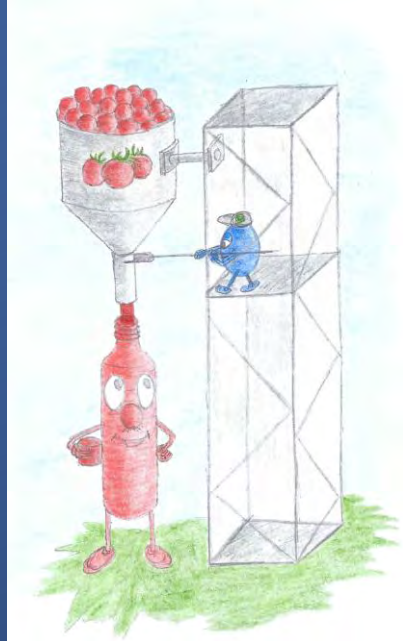
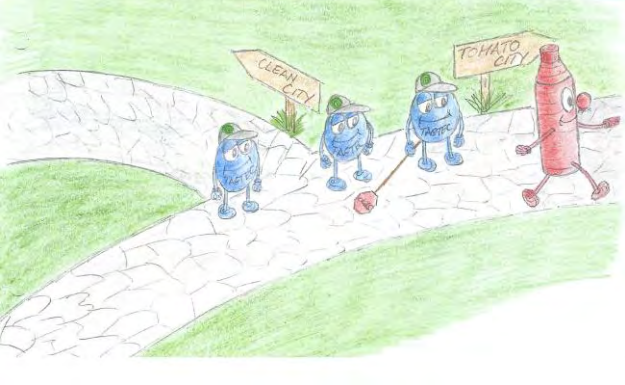
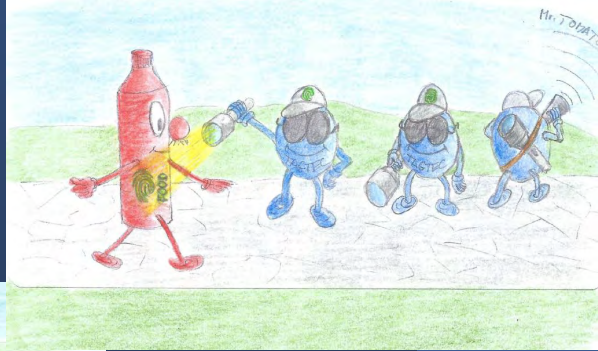
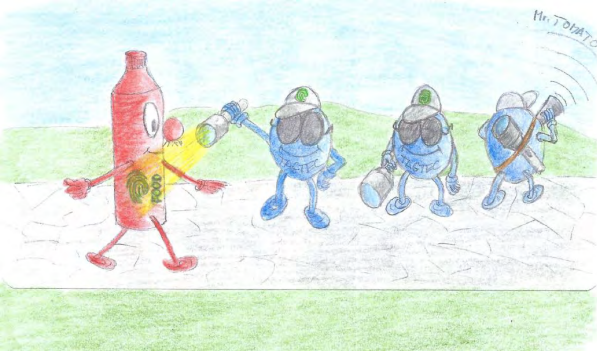
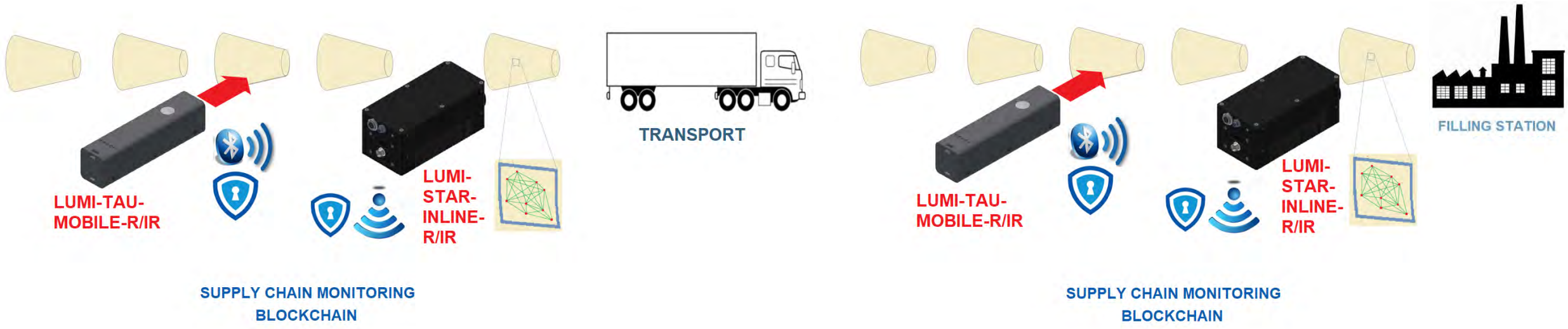

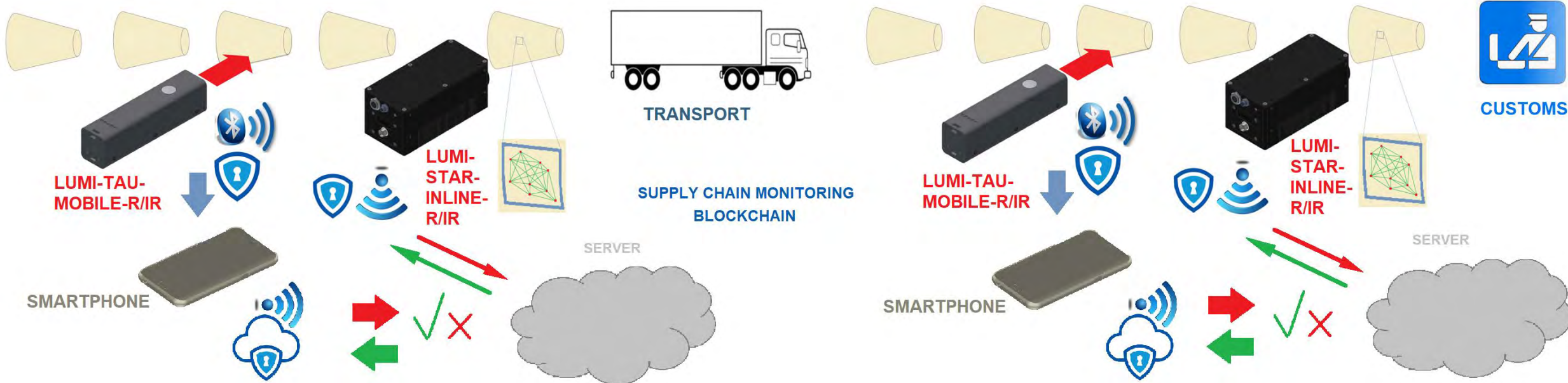

At the individual points in the supply chain, a check can now be carried out using INLINE or MOBILE devices. With the help of the TAU devices, the group code can be monitored, while the STAR devices determine a code that applies individually to the respective object.

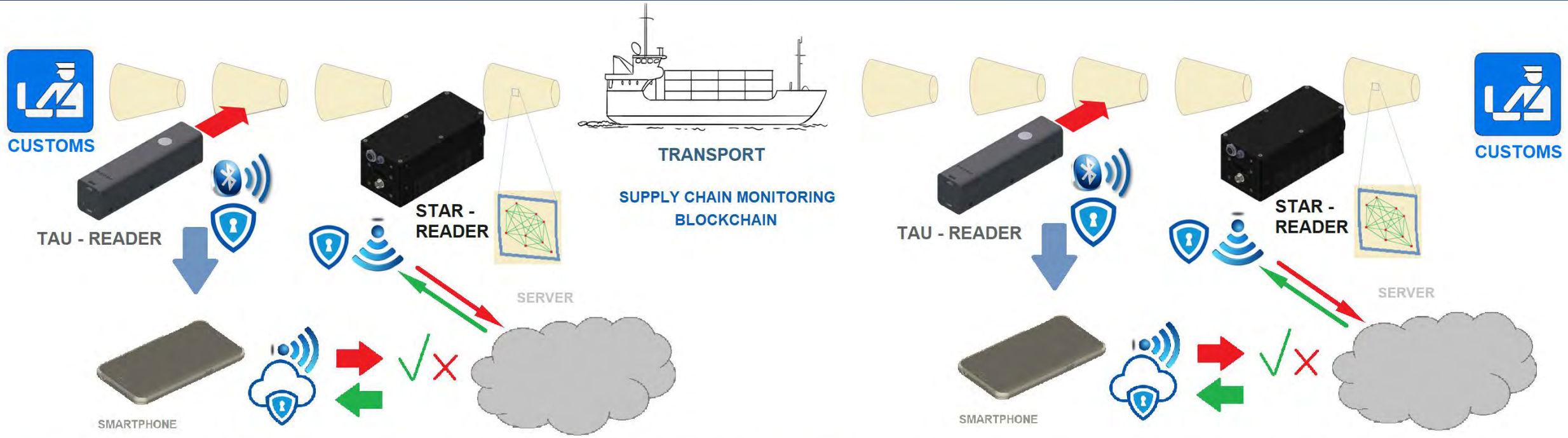

With the help of the block chain technology, the relevant data can now be queried at the individual control points. A fault in the chain can be detected immediately.

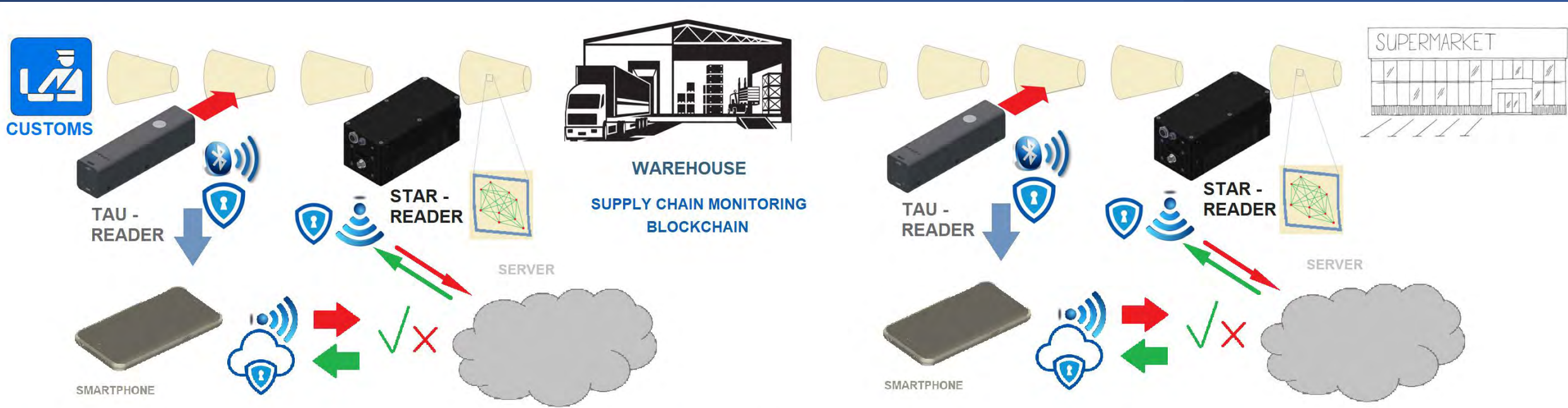

Supply chain verification usually extends to B2B - exchange of goods, thus product tracking usually ends at B2C - exchange of goods.

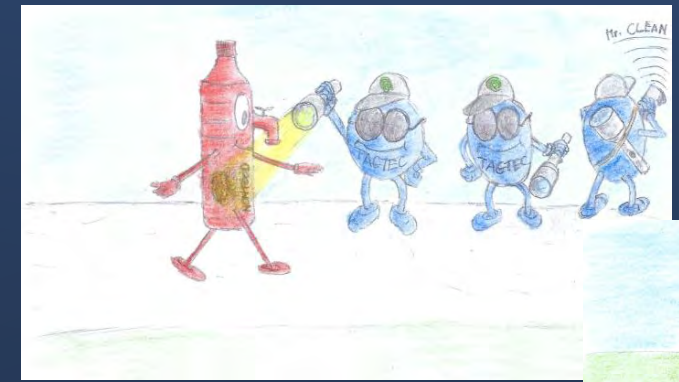
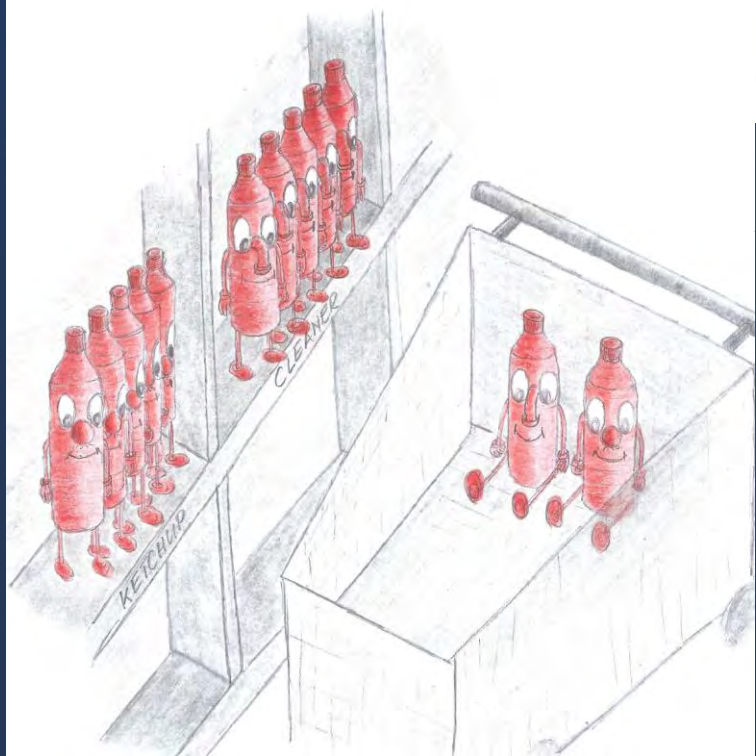
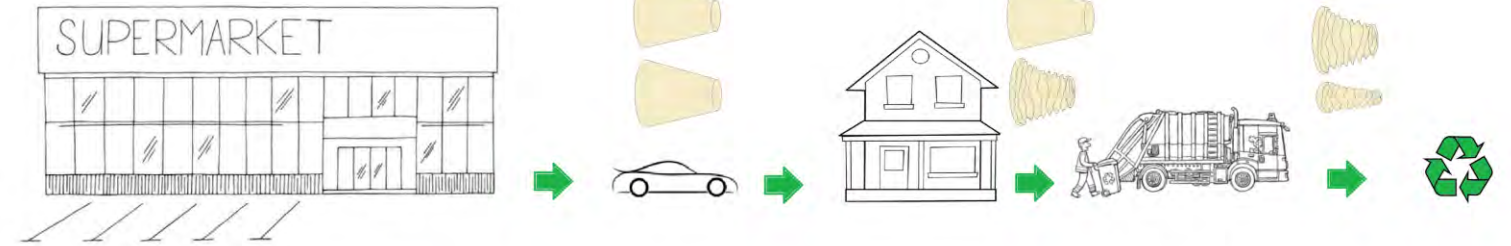

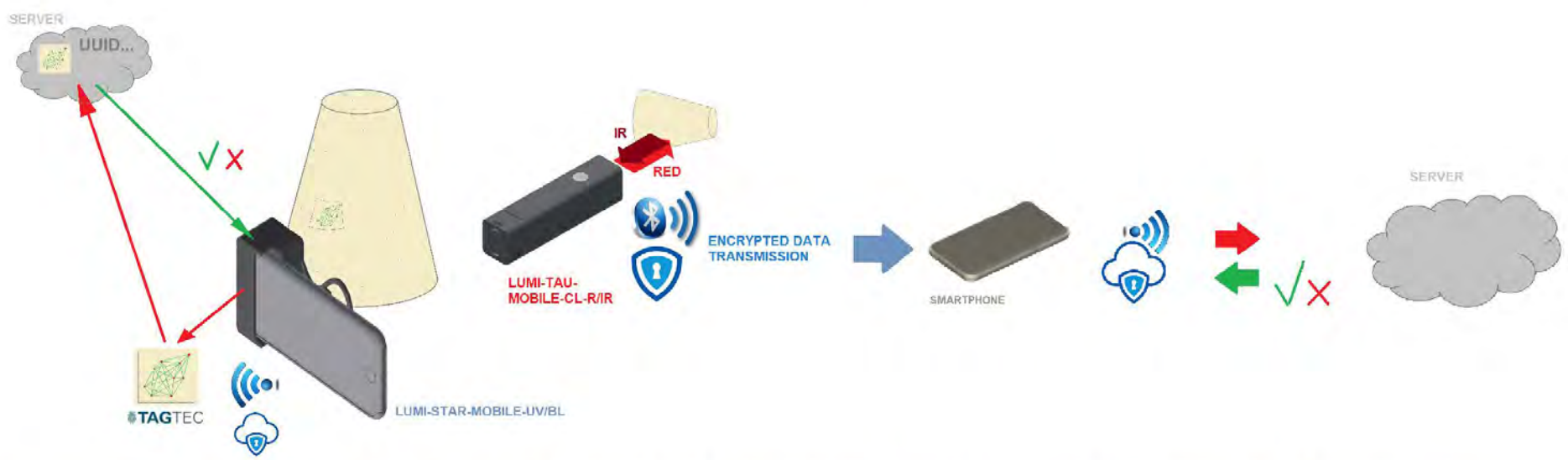
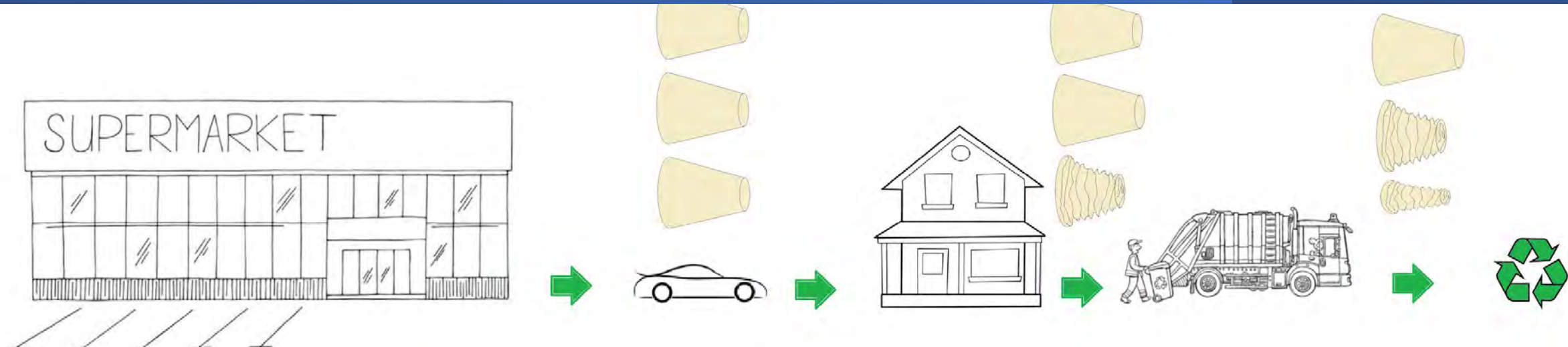

But also in the C - range the consumer has the possibility to control the plastic packaging by means of a mobile STAR- or TAU- reader. However, the verification of the STAR - code usually ends at a deformation of the packaging. With the TAU - Reader, however, even deformed packages can still be detected clearly.

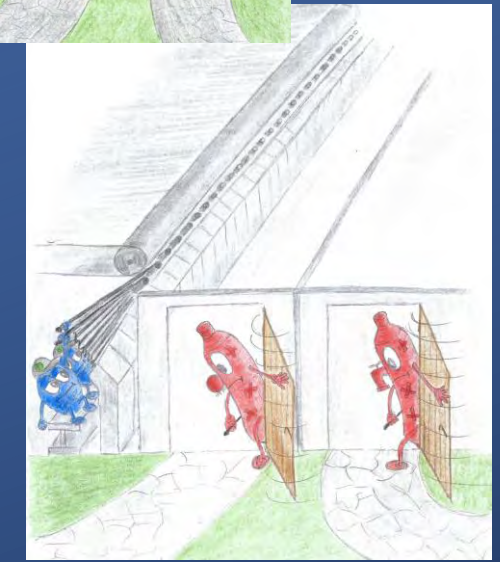
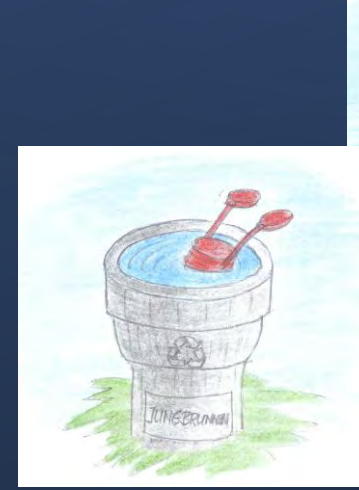
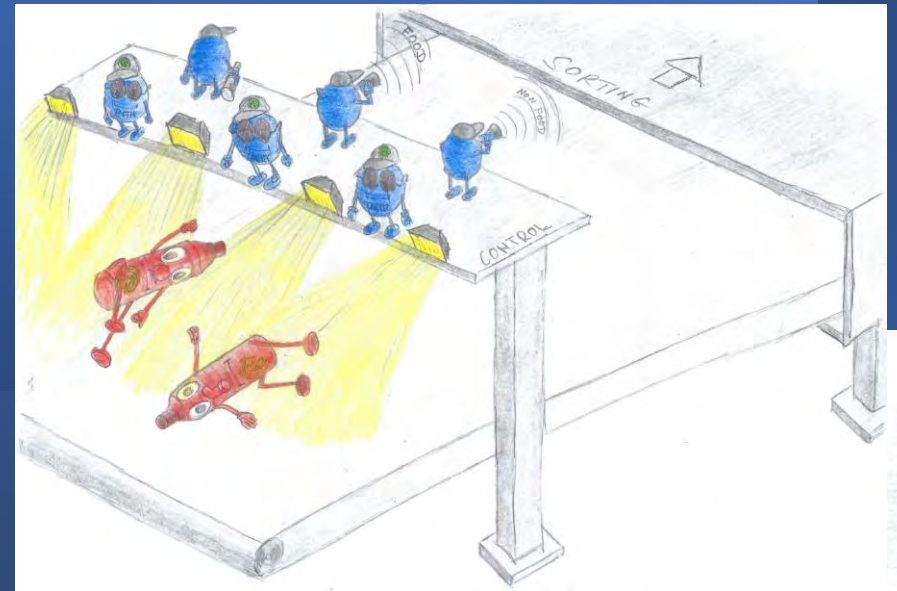
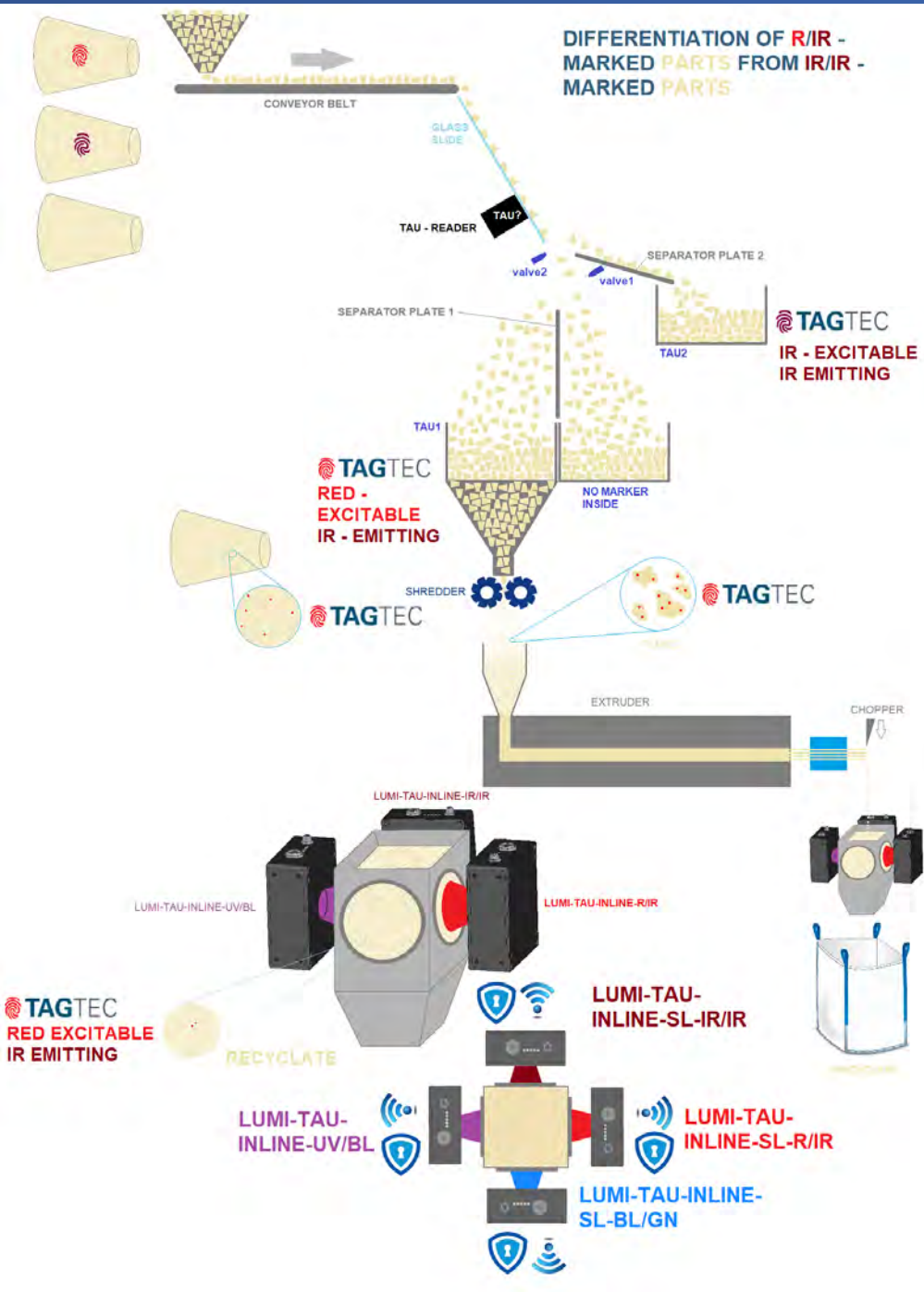

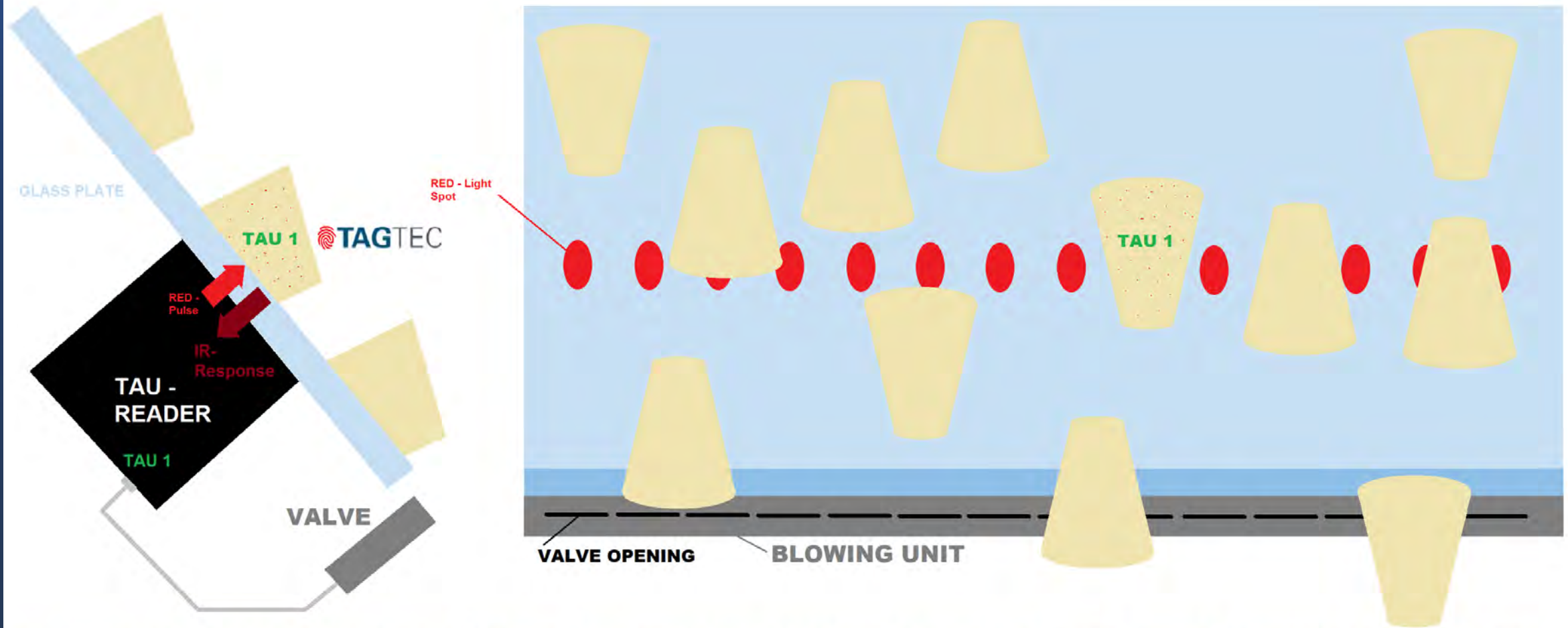

Now, in order to sort a sufficient quantity of plastic packaging per unit of time, several TAU readers must be arranged next to each other. Together, these form a detector line. If an object is detected by a TAU reader (each TAU reader has two excitation light sources and can detect two **TAGTEC** markers at the same time), the blow-off valves assigned to the respective TAU reader are activated with a time delay and the detected plastic packaging is sorted out from the product flow.

LUMI-TAU TECHNOLOGY: MARKER - DETECTION

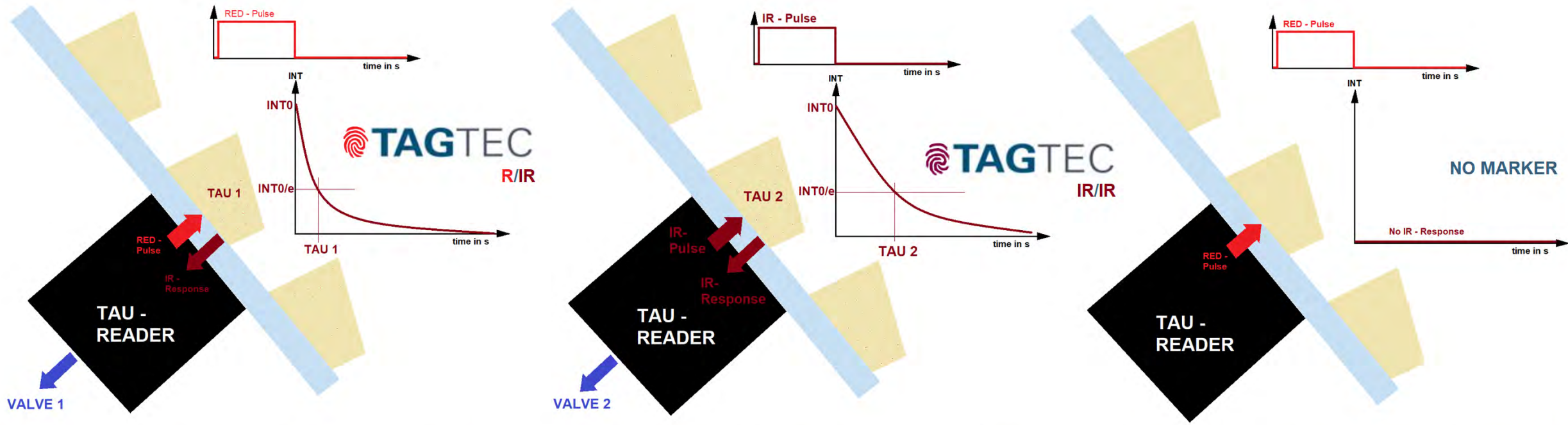

In order to avoid mutual interference of TAGTEC markers, TAGTEC markers are used which cannot influence each other. This is achieved with the help of TAGTEC markers, which react to different excitation wavelengths, but provide no signal response (no secondary emission) in the remaining wavelength range. The time constant (decay time of the signal response) is another indicator for the respective TAGTEC marker.

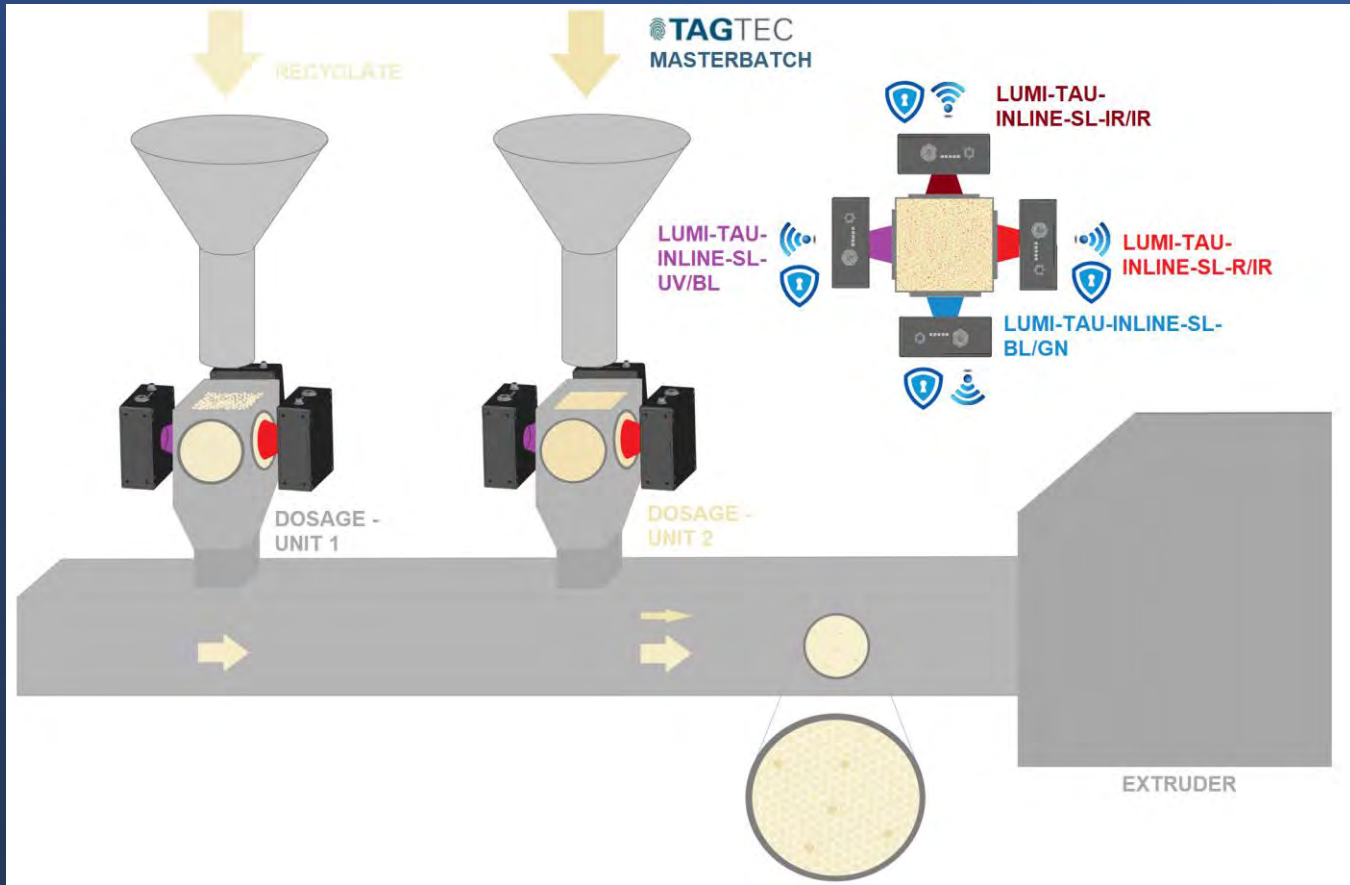

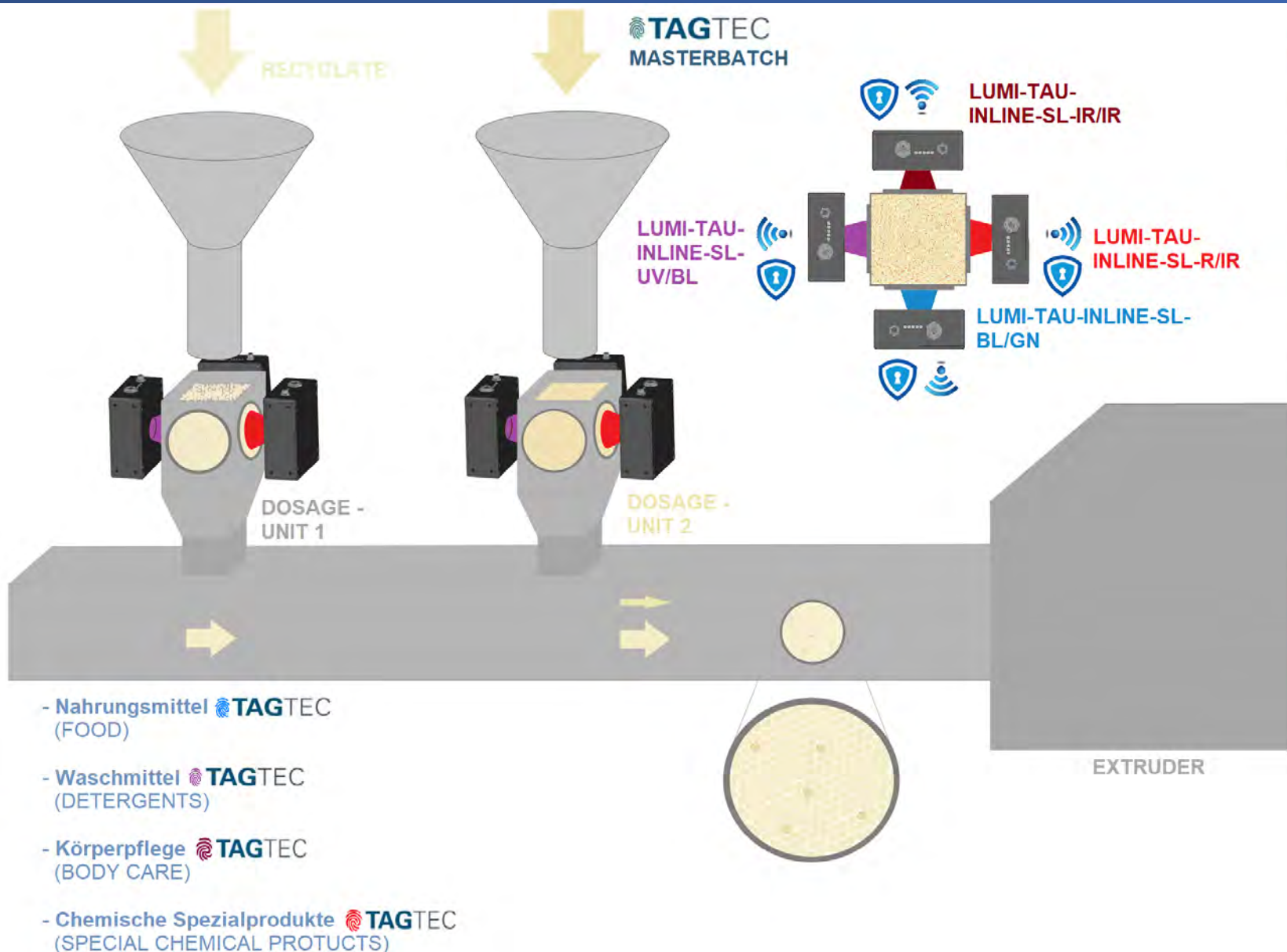

From Pellet to Pellet

Now the cycle is closed, instead of virgin granulate, recycle can now be used. By means of the two dosing units, the TAGTEC marker content intended for the respective plastic packaging can now be set. Both dosing units are equipped with the sensors required to detect the respective TAGTEC marker components. This allows a targeted search for residual TAGTEC markers. For example, if FOOD plastic packaging is produced, the percentage of TAGTEC markers in the recycle should be as high as possible, while the remaining TAGTEC markers (DETERGENTS, BODY CARE, SPECIAL CHEMICAL PRODUCTS) should not exceed a certain percentage threshold. Using a suitable TAGTEC masterbatch, the missing amount of TAGTEC marker (TAGTEC in this example) is then added.

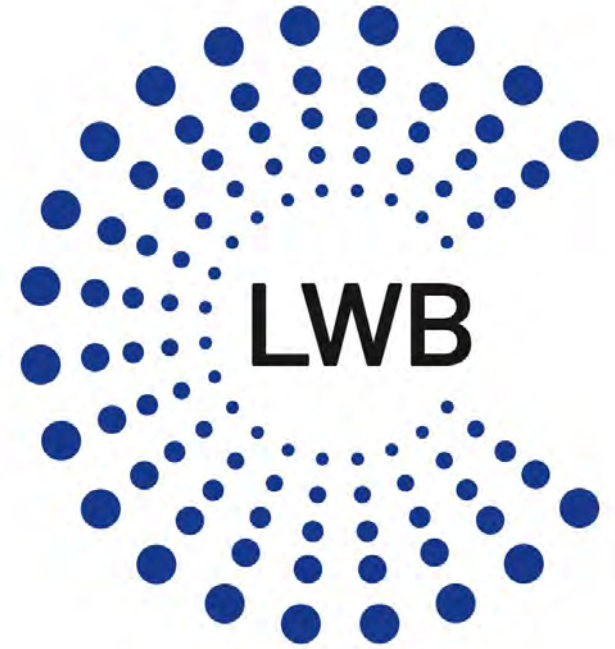

Our plastic is sure to find its way, yours too?



TAGTEC